

# RAD

## Packet Switching Application Guide

Version 5

---

### Notice

This manual contains information that is proprietary to RAD Data Communications. No part of this publication may be reproduced in any form whatsoever without prior written approval by RAD Data Communications.

No representation or warranties for fitness for any purpose other than what is specifically mentioned in this manual is made either by RAD Data Communications or its agents.

For further information contact RAD Data Communications at the address below or contact your local distributor.

<b>RAD Data Communications Headquarters</b>	<b>RAD Data Communications US East</b>	<b>RAD Data Communications US West</b>
12 Hanechoshet Street Tel Aviv 69710 Israel Tel: 972-3-6458181 Fax: 972-3-6498250 E-mail: rad@rad.co.il	900 Corporate Drive Mahwah, NJ 07430 USA Tel: (201) 529-1100 Fax: (201) 529-5777 E-mail: market@radusa.com	3631 South Harbor Boulevard Suite 250 Santa Ana, CA 92704 Tel: (714) 850-0555 Fax: (714) 850-1555

# **Warranty**

This RAD product is warranted against defects in material and workmanship for a period of one year from date of shipment. During the warranty period, RAD will, at its option, either repair or replace products which prove to be defective. For warranty service or repair, this product must be returned to a service facility designated by RAD. Buyer shall prepay shipping charges to RAD and RAD shall pay shipping charges to return the product to Buyer. However, Buyer shall pay all shipping charges, duties and taxes for products returned to RAD from another country.

## **Limitation of Warranty**

The foregoing warranty shall not apply to defects resulting from improper or inadequate maintenance by Buyer, Buyer-supplied firmware or interfacing, unauthorized modification or misuse, operation outside of the environmental specifications for the product, or improper site preparation or maintenance.

## **Exclusive Remedies**

The remedies provided herein are the Buyer's sole and exclusive remedies. RAD shall not be liable for any direct, indirect special, incidental, or consequential damages, whether based on contract, tort, or any legal theory.

# Contents

## CHAPTER 1 INTRODUCTION

1.1 Overview .....	1-1
1.2 How to Use this Application Guide.....	1-2
Manual Contents.....	1-2
Symbols and Conventions .....	1-3

## CHAPTER 2 APPLICATIONS

2.1 X.28 to X.25 .....	2-2
Terminal Configuration Procedures .....	2-2
RADview Configuration Procedures.....	2-3
2.2 X.28 to Frame Relay .....	2-5
Terminal Configuration Procedures .....	2-6
RADview Configuration Procedures.....	2-7
2.3 X.28 to X.25 Over Frame Relay .....	2-9
Terminal Configuration Procedures .....	2-10
RADview Configuration Procedures.....	2-12
2.4 SLIP to X.25.....	2-14
Terminal Configuration Procedures .....	2-15
2.5 SLIP to Frame Relay.....	2-20
Terminal Configuration Procedures .....	2-21
2.6 Asynchronous PPP.....	2-23
Terminal Configuration Procedures .....	2-24
2.7 Multilink PPP - Bandwidth on Demand .....	2-31
Terminal Configuration Procedures .....	2-32
2.8 X.25 to X.25 .....	2-41
Terminal Configuration Procedures .....	2-41
RADview Configuration Procedures.....	2-45
2.9 X.32 Dialup Link.....	2-49
Terminal Configuration Procedures .....	2-50
2.10 NUI Asynchronous to Synchronous.....	2-55
Terminal Configuration Procedures .....	2-55
2.11 NUI Synchronous to Synchronous .....	2-60
Terminal Configuration Procedures .....	2-61
2.12 ISDN Backup Link (X.25 Network).....	2-66
Terminal Configuration Procedures .....	2-68
2.13 Frame Relay Network/Frame Relay User .....	2-78
Terminal Configuration Procedures .....	2-79
RADview Configuration Procedures.....	2-83
2.14 Backup DLCI.....	2-88
Terminal Configuration Procedures .....	2-89
RADview Configuration Procedures.....	2-91

2.15 X.25 Over Frame Relay.....	2-94
Terminal Configuration Procedure.....	2-95
RADview Configuration Procedures.....	2-98
2.16 ISDN Backup Link (Frame Relay Network).....	2-101
Terminal Configuration Procedures .....	2-103
2.17 Frame Relay Multicast.....	2-111
Terminal Configuration Procedures .....	2-112
2.18 HDLC Encapsulated Over Frame Relay.....	2-117
Terminal Configuration Procedures .....	2-117
RADview Configuration Procedures.....	2-121
2.19 HDLC Encapsulated Over X.25.....	2-125
Terminal Configuration Procedures .....	2-125
RADview Configuration Procedures.....	2-129
2.20 HDLC to HDLC (PS as Rate Converter).....	2-132
Terminal Configuration Procedures .....	2-133
RADview Configuration Procedures.....	2-137
2.21 LAN Ethernet Application (Routing) .....	2-139
Terminal Configuration Procedures .....	2-141
2.22 LAN Ethernet Application (Bridging).....	2-152
Terminal Configuration Procedures .....	2-153
2.23 IP Switching Application .....	2-160
Terminal Configuration Procedures .....	2-162
2.24 Routing IP Application (RIP).....	2-173
Terminal Configuration Procedures .....	2-175
2.25 Telnet Client.....	2-182
Terminal Configuration Procedures .....	2-183
Telnet Commands.....	2-184
2.26 Telnet Server .....	2-183
Terminal Configuration Procedures .....	2-184

**CHAPTER 3 STANDARD CHANNEL/LINK CONFIGURATIONS**

3.1 Asynchronous Channel Configuration .....	3-2
Terminal Configuration Procedures .....	3-2
RADview Configuration Procedure.....	3-5
3.2 X.25 Link Configuration .....	3-7
Terminal Configuration Procedures .....	3-7
RADview Configuration Procedure.....	3-11
3.3 Frame Relay Link Configuration .....	3-14
Terminal Configuration Procedures .....	3-14
RADview Configuration Procedure.....	3-19
3.4 HDLC Link Configuration .....	3-22
Terminal Configuration Procedures .....	3-22
RADview Configuration Procedure.....	3-24

# Chapter 1

---

## Introduction

---

---

### 1.1 Overview

RAD's packet switching family includes Packet Assemblers/Disassemblers (PADs) and multiprotocol packet switches (PSs). These products can be used to construct high-performance, private X.25/Frame Relay networks or efficient extensions of public X.25/Frame Relay networks. In addition, RAD's packet switching products support the following protocols and environments:

- Asynchronous - X.28, SLIP, PPP
- X.25
- Frame Relay, Multicast
- HDLC
- Bisynchronous (BSC)
- LAN Ethernet - Routing, Bridging
- IP, RIP-1, RIP-2
- ISDN
- Telnet

---

---

## 1.2 How to Use this Application Guide

This application guide describes typical configuration procedures for the most common packet switching applications. It is a supplement to the *RAD Packet Switching Guide* and also, if your application includes the RADview Network Management System, the *RADview-PC for Packet Switching Applications User's Reference Manual*. For explanations about general operation procedures, functions, and technical terms, see the above-mentioned publications.

**Manual Contents** The following is a description of the contents of this manual

### Chapter 2 - Applications

In **Chapter 2, "Applications"**, each section includes procedures for configuring RAD packet switching products in a specific application. The types of applications include Asynchronous, X.25, Frame Relay, HDLC, LAN (Ethernet), and IP. A typical application section is organized as follows:

- Brief description of the application and its purpose
- List of the application's configuration procedures.
- Diagram showing a typical version of the application. The diagram includes a display of the application's configuration procedures and the channel/link where each procedure is performed.
- Terminal Configuration Procedures. These procedures include step-by-step instructions for configuring one or more packet switches from the Packet Switch command facility in a dumb terminal.
- RADview Configuration Procedures. These procedures include step-by-step instructions for configuring one or more packet switches from a RADview network management station. This section is applicable only for applications supported by RADview.



**RAD**view

### Chapter 3 - Standard Channel/Link Applications

Chapter 3, “Standard Channel/Link Applications”, contains configuration procedures for typical X.28 (Asynchronous), X.25, Frame Relay and HDLC connections. These procedures include the usual steps for setting up a channel/link operating in one of the above-mentioned protocols. Unless noted otherwise, these procedures instruct you to set parameters according to your application’s specifications instead of supplying specific settings.

A typical procedure from this chapter, or several of its steps, is often a part of the larger configuration process of an application described in **Chapter 2**.

**Chapter 2** contains references to these procedures at the appropriate places.

A standard channel/link configuration section is organized as follows:

- List of the channel/link’s configuration procedures.
- Terminal Configuration Procedures. These procedures include step-by-step instructions for configuring a typical channel/link from the Packet Switch command facility in a dumb terminal.
- RADview Configuration Procedures. These procedures include step-by-step instructions for configuring a typical channel/link from a RADview network management station. This section is applicable only for protocols supported by RADview.



**RAD**view

### Symbols and Conventions

The following items and their descriptions explain the standards used in this manual

- Choosing an item** Terminal configuration procedures - Choose an option by typing the option number and pressing ENTER.  
RADview configuration procedures - Choose (“click”) an item by placing the pointer over the specified item and clicking the left mouse button.
- Bold characters** Specific text that you type. For example, if the guide says to choose **3**, press the “3” key at the specified location.  
(RADview only) Specific option or command that you click. For example, if the guide says, “In the **Configuration** menu, click **Parameters**,” click **Configuration** in the menu bar and then click **Parameters**.
-  Indicates section containing procedures for configuring an application from a dumb terminal connected directly to the packet switching device.
- RAD**view Indicates section containing procedures for configuring an application from a RADview network management station.



Indicates specific option in a Packet Switch command facility menu that you have to choose.

If this arrow points to a line stating "Select:" or "Enter one of the above values or <RETURN> to exit," an exact option or value is not specified in the current step.

"See Section number, section name. Perform steps x to y. Afterwards, perform the following steps:"

After performing the specified steps ("x to y") in the referred procedure, proceed to the steps written in the current procedure. The step numbering in the current procedure begins after the steps in the referred procedure.

For example, if the guide says to perform steps 1 to 3 in a referred procedure, the following steps in the current procedure will proceed from number 4.

"Channel x",  
"Link x",  
"DLCI xxx", etc.

x indicates the number of the selected channel, link, DLCI, etc. in a menu name or a screen name.



# Chapter 2

---

## Applications

This chapter contains procedures for configuring RAD packet switching products in the following applications:

- X.28 to X.25
- X.28 to Frame Relay
- X.28 to X.25 Over Frame Relay
- SLIP to X.25
- SLIP to Frame Relay
- Asynchronous PPP
- Multilink PPP - Bandwidth on Demand
- X.25 to X.25
- X.32 Dialup Link
- NUI Asynchronous to Synchronous
- NUI Synchronous to Synchronous
- ISDN Backup Link (X.25 Network)
- Frame Relay Network/Frame Relay User
- Backup DLCI
- X.25 Over Frame Relay
- ISDN Backup Link (Frame Relay Network)
- Frame Relay Multicast
- HDLC Encapsulated Over Frame Relay
- HDLC Encapsulated Over X.25
- HDLC to HDLC (PS as Rate Converter)
- QLLC to QLLC
- LAN Ethernet Application (Routing)
- LAN Ethernet Application (Bridging)
- IP Switching Application
- Routing IP Application (RIP)
- Telnet Client
- Telnet Server

## 2.1 X.28 to X.25

Transferring data through an X.28 (Asynchronous) channel over an X.25 network.

This section describes configuration procedures of a packet switching device in an X.28 to X.25 application. These procedures include:

- Configure an X.28 (Asynchronous) channel that connects to a terminal
- Select an X.25 link that connects to an X.25 network
- Set the X.25 link parameters.

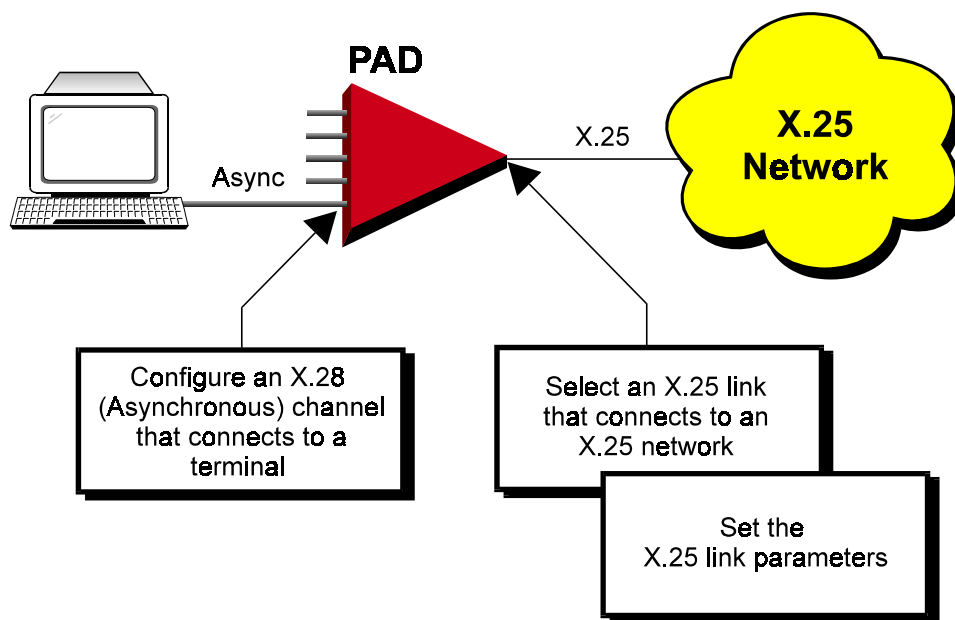

### Terminal Configuration Procedures



The following section describes configuration procedures of a packet switching device in an X.28 to X.25 application

- **Configure an X.28 channel that connects to a terminal**
  - See *Asynchronous Channel Configuration, "Terminal Configuration Procedures."* Perform all steps as instructed.
- **Select an X.25 link that connects to an X.25 network**
  - See *X.25 Link Configuration, "Terminal Configuration Procedures, ➤ Select an X.25 link."* Perform all steps as instructed.

➤ **Set the X.25 link parameters**

**Note** Verify that the X.25 link is DTE.

1. In the Link x Configuration menu, choose **2** (DCE/DTE).

```

X.25 Link 1 configuration
-----
1) Address ..... [0 ] 17) LGN ..... [0 ]
2) DCE (1) / DTE (0)..... [1 ] 18) Lowest LCN (LIC) ..... [1 ]
3) Extended mode ..... [0 ] 19) Amount of Incoming LCNs .. [5 ]
4) T1 ..... [5 ] 20) Amount of Two Way LCNs ... [5 ]
5) T3 ..... [20 ] 21) Amount of Outgoing LCNs .. [5 ]
6) N2 ..... [10 ] 22) Internal Clock ..... [0 ]
7) k ..... [7 ] 23) LINE option ..... [1024 ]
8) w ..... [2 ] 24) Segment Size..... [128 ]
9) T10 ..... [18 ] 25) Xid num ..... [0 ]
10) T11 ..... [20 ] 26) NUI Group ID ..... [0 ]
11) T12 ..... [18 ] 27) Physical interface option. [0 ]
12) T13 ..... [18 ] 28) X.25 Acknowledge Counter . [1 ]
13) Packet size ..... [128 ] 29) X.25 Acknowledge Timer ... [0 ]
14) In call options ..... [1 ] 30) LAPB Acknowledge Counter . [1 ]
15) Out call options ..... [1 ] 31) LAPB Acknowledge Timer ... [0 ]
16) Subaddress length ..... [2 ] 32) CUG subscription ..... [5 ]
S) Save
CR) Exit

Select:
    
```

2. In the DCE/DTE screen, choose **0** (X.25 DTE).

```

2) DCE/DTE
-----
Current value ... [1 ]

Possible values:
0 - The link appears as a X25 DTE.
1 - The link appears as a X25 DCE.
2 - The link is X25->DCE and LAPB->DTE.
3 - The link is X25->DTE and LAPB->DCE.

Enter one of the above values or <RETURN> to exit:
    
```

3. In the Link x Configuration menu, change other parameters according to your specifications or keep their default values. Choose **S** to save the configuration.

**RADview Configuration Procedures**



The following describes the RAD configuration procedures of a packet switching device in an Asynchronous application.

➤ **Configure an Asynchronous channel that connects to a terminal**

- See *Asynchronous Channel Configuration, "RADview Configuration Procedures"*. Perform all steps as instructed.

➤ **Select an X.25 link that connects to an X.25 network**

- See *X.25 Link Configuration, "RADview Configuration Procedures, ➤ Select an X.25 link."* Perform all steps as instructed.

➤ **Set the X.25 link parameters**

**Note** Verify that the X.25 link is DTE.

1. In the PS View window, double-click the X.25 link. The X.25 window appears.

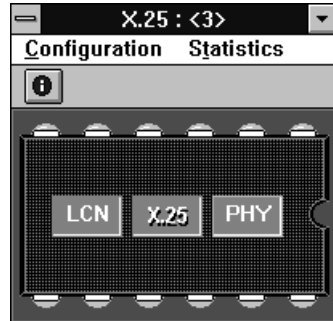

2. In the X.25 window, click **X.25**. On the **X.25 Configuration** menu, point to **Parameters** and click **Quick Config**. In the X.25 Quick Config dialog box, click **Scratch** to switch to the Scratch configuration mode.

Field	Value
Index:	1
Local Address:	0
DCE-DTE:	DCE
Extended Mode:	mod8
K:	7
W:	2
Packet Size:	128
LIC:	1
Incoming LCNs:	5
Two-way LCNs:	5
Outgoing LCNs:	5
Internal Clock (bps):	0

3. In the DCE/DTE list, click **DTE**.
4. Change other link parameters according to your specifications or keep their default values. Click **Set**.

## 2.2 X.28 to Frame Relay

Transferring data using encapsulated X.25 protocol through X.28 (Asynchronous) channels over a Frame Relay network.

This section describes configuration procedures of a packet switching device in an X.28 to X.25 over Frame Relay application. These procedures include:

- Configure an X.28 channel that connects to a terminal
- Set a link to Frame Relay
- Set the Frame Relay port parameters
- Add and configure a DLCI

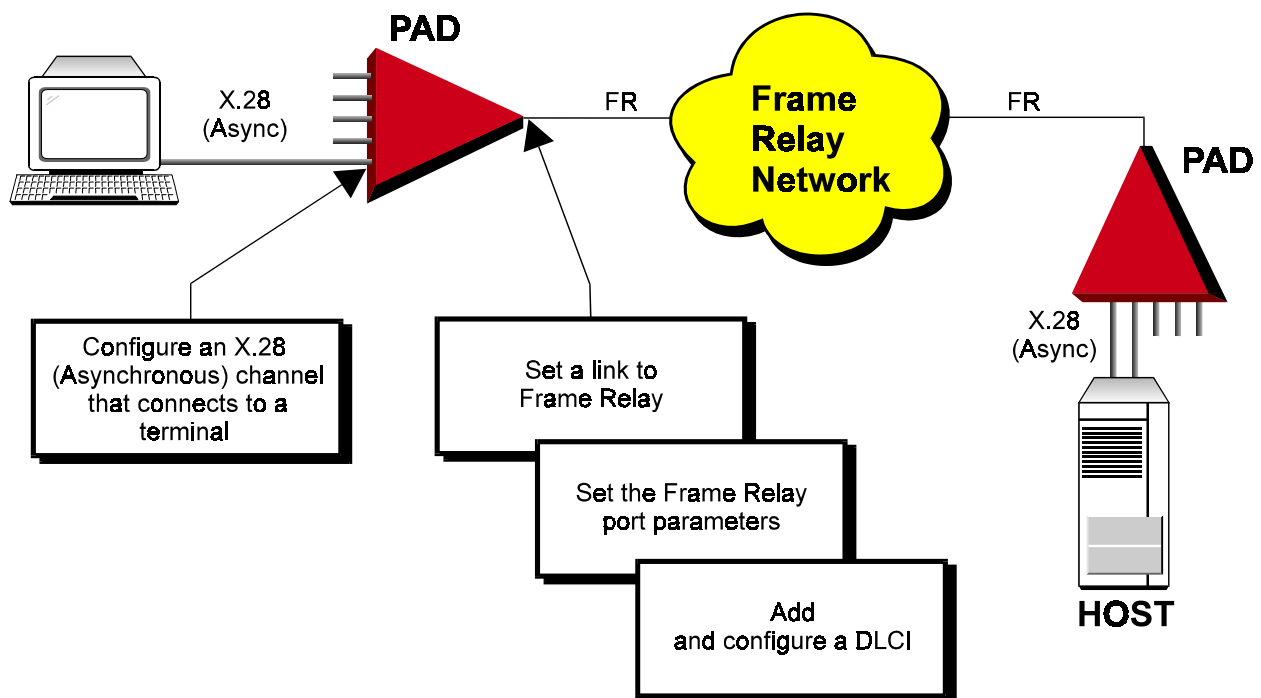

## Terminal Configuration Procedures



The following section describes configuration procedures of a packet switching device in an X.28 to X.25 over Frame Relay application.

### ➤ Configure an X.28 channel that connects to a terminal

- See *Asynchronous Channel Configuration, "Terminal Configuration Procedures."* Perform all steps as instructed.

### ➤ Set a link to Frame Relay

- See *Frame Relay Link Configuration, "Terminal Configuration Procedures, ➤ Set a link to Frame Relay."* Perform all steps as instructed.

### ➤ Set the Frame Relay port parameters

- See *Frame Relay Link Configuration, "Terminal Configuration Procedures, ➤ Set the Frame Relay port parameters."* Perform steps 1 to 5 of the procedure. Afterwards, perform the following steps:

1. In the Maintenance Protocol Mode screen, choose **0** (User-side).

```

2) Maintenance protocol mode
-----
This field defines the mode of maintenance protocol running
over this port.
Current value ... [1    ]

Possible values:
0 - Perform user-side procedure on this port.
1 - Perform network-side procedure on this port.
2 - Perform NNI (Network to Network Interface) procedure
   on this port.

Enter one of the above values or <RETURN> to exit:

```

2. In the Frame Relay Port x Configuration menu, change other port parameters according to your network specifications or keep their default values. Choose **S** to save the configuration.

### ➤ Add and configure a DLCI

- See *Frame Relay Link Configuration, "Terminal Configuration Procedures, ➤ Add and configure a DLCI."* Perform steps 1 to 3 of the procedure. Afterwards, perform the following steps:

1. In the Encapsulation Type screen, choose **4** (Asynchronous Encapsulation).

```

1) Encapsulation Type
-----
Current value ... [2    ]

Possible values:
1 - X25 encapsulation.
2 - No protocol encapsulation.
3 - Transparent HDLC encapsulation.
4 - Asynchronous encapsulation.
5 - Multi Point Encapsulation.
6 - RFC1490 encapsulation.
7 - Multicast

Enter one of the above values or <RETURN> to exit:

```

- In the DLCI xxx Link x Configuration menu, choose **2** (Destination Id). In the Destination Id screen, type the number of the Asynchronous channel that you configured in the procedure, “► *Configure an X.28 channel that connects to a terminal*”, earlier in this section.

```

2) Destination id
-----
This field is used only if the Encapsulation Type value is 2 or
4.
Current value ... [0:0 ]

Possible values:
  A pair of Port and existing DLCI, with Encapsulation Type
value 2.
  An existing Async. Channel, if the Encapsulation Type of
this DLCI is 4.

Enter one of the above values or <RETURN> to exit:

```

- Change other DLCI parameters according to your network specifications or keep their default values. Choose **S** to save the configuration.

The following are the RADview procedures necessary to configure an X.28 to X.25 over Frame Relay application.

## RADview Configuration Procedures



### ► Configure an Asynchronous channel that connects to a terminal

- See *Asynchronous Channel Configuration, “RADview Configuration Procedures.”* Perform all steps as instructed.

### ► Set a link to Frame Relay

- See *Frame Relay Link Configuration, “RADview Configuration Procedures, ► Set a link to Frame Relay.”* Perform all steps as instructed.

### ► Set the Frame Relay ports parameters

- In the PS View window, double-click the Frame Relay link. The FR window appears.

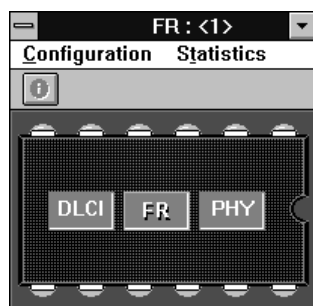

- In the FR window, click FR. On the FR Configuration menu, point to Parameters and click Quick Config. In the FR Quick Config dialog box, click Scratch to switch to the Scratch configuration mode.

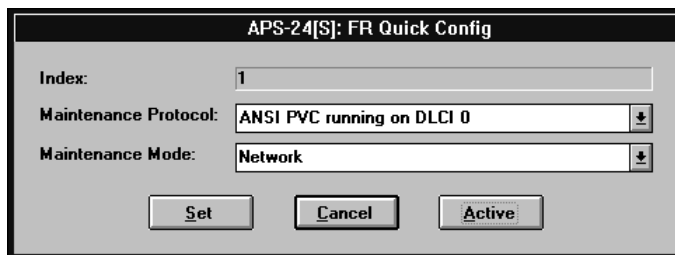

- In the Maintenance Mode list, click **User**. Click **Set**.

**Note**

If you want to change additional port parameters according to your specifications, open the FR Configuration menu, point to **Parameters** and click **Full Config** to open the Full Config dialog box.

- On the FR Configuration menu, click **Save**. Click **OK** to confirm.

➤ **Add and configure a DLCI**

- See *Frame Relay Link Configuration, "RADview Configuration Procedures, ➤ Add and configure a DLCI."* Perform steps 1 and 2 of the procedure. Afterwards, perform the following steps:

- The Add DLCI Parameters dialog box appears. In the Destination Protocol list, click **Async**.

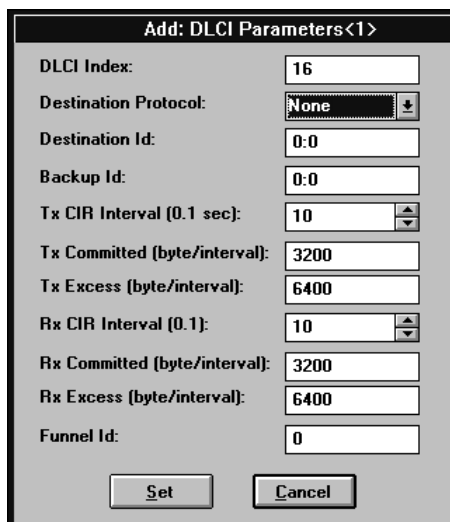

- In the Destination ID box, type the number of the Asynchronous channel that you configured in the procedure, "**➤ Configure an X.28 channel that connects to a terminal**", earlier in this section.
- Change other DLCI parameters according to your network specifications or keep their default values. Click **Set**.
- In the DLCI Parameters table, click the new DLCI, click **Save** and then click **Entry**.  
To save the complete DLCI table, click **Save** and then click **All**.



## 2.3 X.28 to X.25 Over Frame Relay

Transferring data using encapsulated X.25 protocol through X.28 (Asynchronous) channels over a Frame Relay network.

This section describes configuration procedures of a packet switching device in an X.28 to X.25 over Frame Relay application. These procedures include:

- Configure an X.28 channel that connects to a terminal
- Set a link to Frame Relay
- Set the Frame Relay port parameters
- Add and configure a DLCI
- Set X.25 encapsulation parameters for the Frame Relay link
- Add a routing table entry.

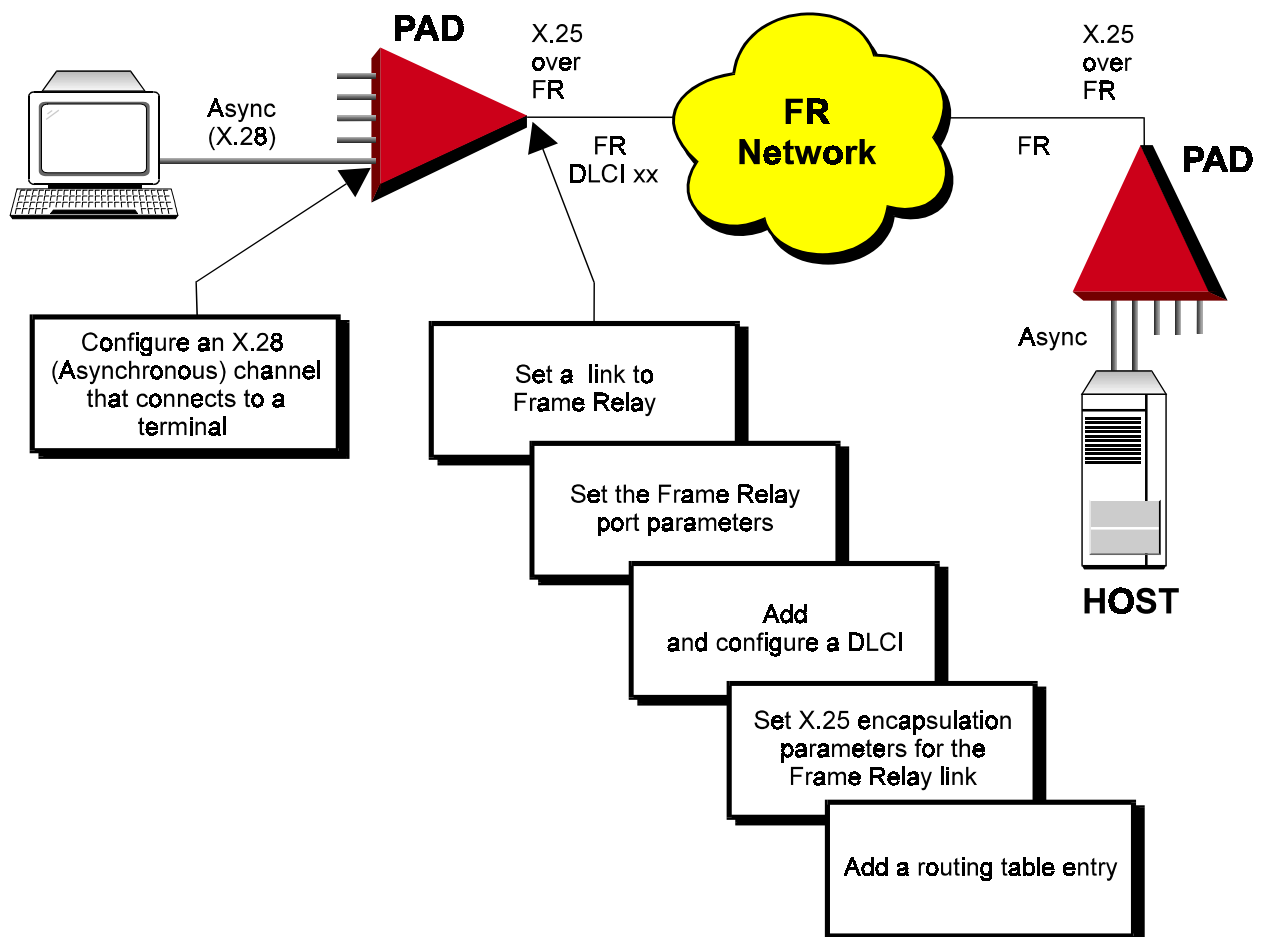

## Terminal Configuration Procedures



This section describes configuration procedures of a packet switching device in an X.28 to X.25 over Frame Relay application.

### ➤ Configure an X.28 channel that connects to a terminal

- See *Asynchronous Channel Configuration, "Terminal Configuration Procedures."* Perform all steps as instructed.

### ➤ Set a link to Frame Relay

- See *Frame Relay Link Configuration, "Terminal Configuration Procedures, ➤ Set a link to Frame Relay."* Perform all steps as instructed.

### ➤ Set the Frame Relay port parameters

- See *Frame Relay Link Configuration, "Terminal Configuration Procedures, ➤ Set the Frame Relay port parameters."* Perform steps 1 to 5 of the procedure. Afterwards, perform the following steps:

1. In the Maintenance Protocol Mode screen, choose **0** (User-side).

```

2) Maintenance protocol mode
-----
This field defines the mode of maintenance protocol running
over this port.
Current value ... [1    ]

Possible values:
0 - Perform user-side procedure on this port.
1 - Perform network-side procedure on this port.
2 - Perform NNI (Network to Network Interface) procedure
   on this port.

Enter one of the above values or <RETURN> to exit:

```

2. In the Frame Relay Port x Configuration menu, change other port parameters according to your network specifications or keep their default values. Choose S to save the configuration.

### ➤ Add and configure a DLCI

- See *Frame Relay Link Configuration, "Terminal Configuration Procedures, ➤ Add and configure a DLCI."* Perform steps 1 to 3 of the procedure. Afterwards, perform the following steps:

1. In the Encapsulation Type screen, choose **1** (X.25 Encapsulation).

```

1) Encapsulation Type
-----
Current value ... [2    ]

Possible values:
1 - X25 encapsulation.
2 - No protocol encapsulation.
3 - Transparent HDLC encapsulation.
4 - Asynchronous encapsulation.
5 - Multi Point Encapsulation.
6 - RFC1490 encapsulation.
7 - Multicast

Enter one of the above values or <RETURN> to exit:

```

- Change other DLCI parameters according to your network specifications or keep their default values. Choose **S** to save the configuration.

► **Set X.25 encapsulation parameters for the Frame Relay link**

- Press ENTER several times so that the DLCI xxx Link x menu reappears. In the DLCI xxx Link x menu, choose **2** (Update X.25 Configuration).

```

DLCI 100  Link 3
-----
1) Update DLCI configuration.
2) Update X25 configuration.
CR) Exit

Select:

```

- In the X.25 Link x DLCI xxx Configuration menu, choose **2** (DCE/DTE).

```

X.25 Link 3 DLCI 100 configuration
-----
1) Address ..... [0 ] 17) LGN ..... [0 ]
2) DCE (1) / DTE (0)..... [1 ] 18) Lowest LCN (LIC) ..... [1 ]
3) Extended mode ..... [0:0 ] 19) Amount of Incoming LCNs .. [5 ]
4) T1 ..... [5 ] 20) Amount of Two Way LCNs ... [5 ]
5) T3 ..... [20 ] 21) Amount of Outgoing LCNs .. [5 ]
6) N2 ..... [10 ] 22) Internal Clock ..... [0 ]
7) k ..... [7 ] 23) LINE option ..... [1024 ]
8) w ..... [2 ] 24) Segment Size..... [128 ]
9) T10 ..... [18 ] 25) Xid num ..... [0 ]
10) T11 ..... [20 ] 26) NUI Group ID ..... [0 ]
11) T12 ..... [18 ] 27) Physical interface option. [0 ]
12) T13 ..... [18 ] 28) X.25 Acknowledge Counter . [1 ]
13) Packet size ..... [128 ] 29) X.25 Acknowledge Timer ... [0 ]
14) In call options ..... [1 ] 30) LAPB Acknowledge Counter . [1 ]
15) Out call options ..... [1 ] 31) LAPB Acknowledge Timer ... [0 ]
16) Subaddress length ..... [2 ] 32) CUG subscription ..... [5 ]
S) Save
CR) Exit

Select:

```

- In the DCE/DTE screen, choose **0** (X.25 DTE).

```

2) DCE/DTE
-----
Current value ... [1 ]

Possible values:
0 - The link appears as a X25 DTE.
1 - The link appears as a X25 DCE.
2 - The link is X25->DCE and LAPB->DTE.
3 - The link is X25->DTE and LAPB->DCE.

Enter one of the above values or <RETURN> to exit:

```

- In the X.25 Link x DLCI xxx Configuration menu, change other X.25 parameters according to your specifications. Choose **S** to save the configuration.

► **Add a routing table entry**

In this application, the routing destination is a valid Frame Relay link with a DLCI.

- See *X.25 Link Configuration, "Terminal Configuration Procedures, ► Add a routing table entry."* Perform all steps as instructed.

## RADview Configuration Procedures



This section describes RADview configuration procedures of a packet switching device in an X.28 to X.25 over Frame Relay application including adding a routing table entry.

- **Configure an X.28 channel that connects to a terminal**
  - See *Asynchronous Channel Configuration, "RADview Configuration Procedures."* Perform all steps as instructed.
- **Set a link to Frame Relay**
  - See *Frame Relay Link Configuration, "RADview Configuration Procedures, ➤ Set a link to Frame Relay."* Perform all steps as instructed.
- **Set the Frame Relay ports parameters**
  1. In the PS View window, double-click the Frame Relay link. The FR window appears.

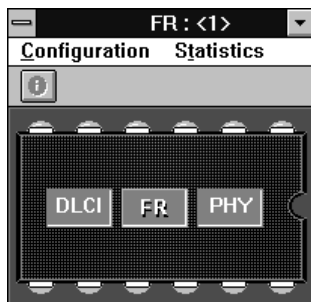

2. In the FR window, click **FR**. On the FR **Configuration** menu, point to **Parameters** and click **Quick Config**. In the FR Quick Config dialog box, click **Scratch** to switch to the Scratch configuration mode.

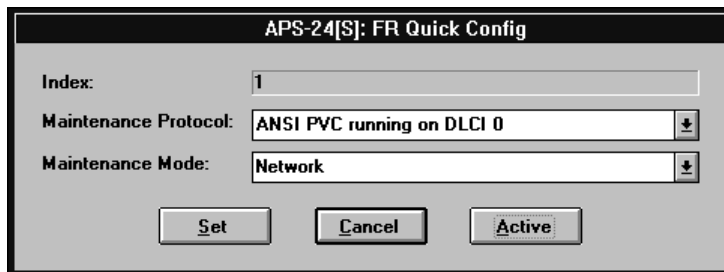

3. In the Maintenance Mode list, click **User**. Click **Set**.

### Note

If you want to change additional port parameters according to your specifications, open the FR Configuration menu, point to **Parameters** and click **Full Config** to open the Full Config dialog box.

4. On the FR Configuration menu, click **Save**. Click **OK** to confirm.

➤ **Add and configure a DLCI**

- See *Frame Relay Link Configuration, "RADview Configuration Procedures, ➤ Add and configure a DLCI."* Perform steps 1 and 2 of the procedure. Afterwards, perform the following steps:
  1. The Add DLCI Parameters dialog box appears. In the Destination Protocol list, click **X.25**. Change other DLCI parameters according to your network specifications or keep their default values. Click **Set**.
  2. In the DLCI Parameters table, click **X.25 Quick Config**.
  3. In the Quick Config dialog box, click **Scratch** to switch to the scratch configuration. In the DCE-DTE list, click **DTE**. Change other X.25 parameters according to your network specifications or keep their default values. Click **Set**.

The screenshot shows a dialog box titled "APS-24[S]: Quick Config". It contains the following configuration parameters:

Index:	3
Local Address:	0
DCE-DTE:	DTE
Extended Mode:	mod8
K:	7
W:	2
Packet Size:	128
LIC:	1
Incoming LCNs:	5
Two-way LCNs:	5
Outgoing LCNs:	5
Internal Clock (bps):	External

At the bottom of the dialog box are three buttons: **Set**, **Cancel**, and **Active**.

4. In the DLCI Parameters table, click the new DLCI, click **Save**, and then click **Entry**.  
To save the complete DLCI table, click **Save** and then click **All**.

➤ **Add a routing table entry**

In this application, the routing destination is a valid Frame Relay link with a DLCI.

- See *X.25 Link Configuration, "RADview Configuration Procedures, ➤ Add a routing table entry."* Perform all steps as instructed.

## 2.4 SLIP to X.25

Transferring data through a SLIP channel over an X.25 network.

This section describes configuration procedures of a packet switching device in a SLIP to X.25 application. These procedures include:

- Set a channel to SLIP
- Set the SLIP channel parameters
- Configure IP interfaces
- Configure X.25 routing table.

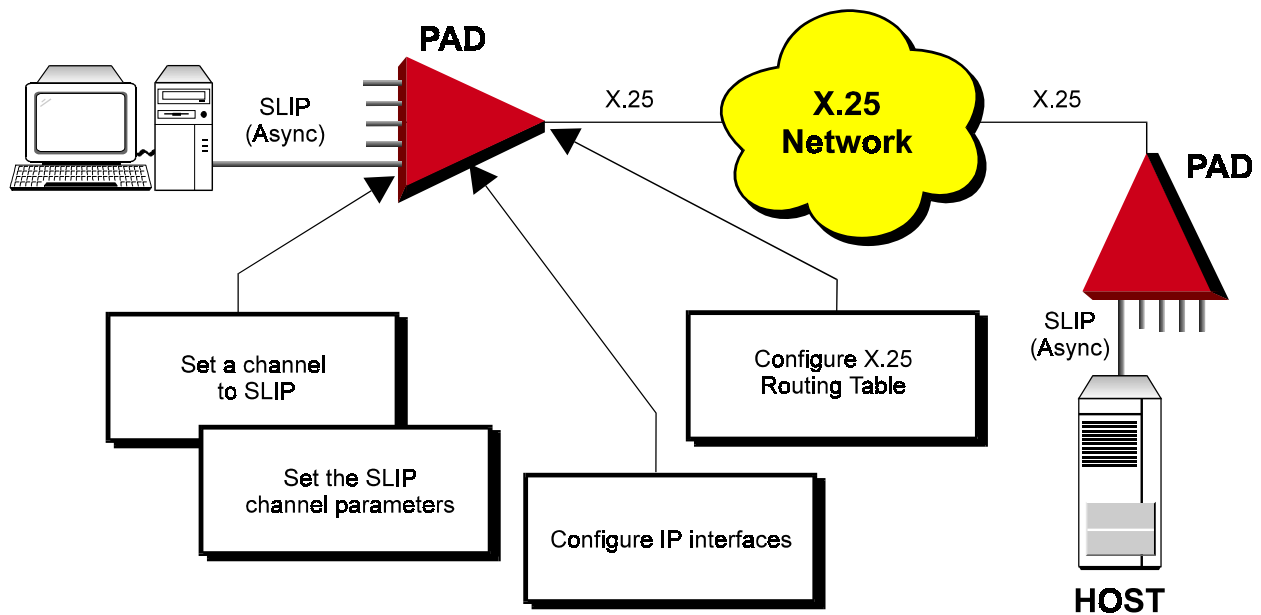

## Terminal Configuration Procedures



The following section describes configuration procedures of a packet switching device in a SLIP to X.25 application.

### ► Set a channel to SLIP

1. In the Configuration menu, choose 1 (Channel).

```

Configuration menu
-----
1) Channel
2) Profile
3) Link
4) System parameters
5) PVC
6) Call ID
7) NUI
8) Alias
9) Routing table
10) Funnel
11) X.32
12) Management
13) Multicast
14) IP configuration
15) ISDN configuration
16) SNA
CR) Exit

Select:

```

2. In the Channel Configuration menu, choose 5 (Set Channel Type).

```

Channel configuration
-----
1) Duplicate channel
2) Duplicate channel with mask
3) Update channel
4) Display channels
5) Set Channel Type
CR) Exit

select:

```

3. Choose the number of the channel that you want to set to SLIP protocol.

```

Chan | 1 | 2 | 3 | 4 | 5 | 6 | 7 | 8 |
-----|-----|-----|-----|-----|-----|-----|-----|-----|
Prot | X.28 | X.28 | X.28 | X.28 | X.28 | X.28 | X.28 | X.28 |

Enter channel number to set:

```

4. In the Channel Protocol Types menu, choose 2 (Slip).

```

Channel Protocol Types
-----
1) X.28
2) Slip
3) PPP
CR) Exit

select:

```

A warning appears stating that this action will set this SLIP channel's parameters to their default values. Choose **Y** to continue.

► **Set the SLIP channel parameters**

1. Press ENTER several times so that the Channel Configuration menu reappears. In the Channel Configuration menu, choose **3** (Update Channel).

```

Channel configuration
-----
1) Duplicate channel
2) Duplicate channel with mask
3) Update channel
4) Display channels
5) Set Channel Type
CR) Exit

select:

```

2. Choose the number of the SLIP channel that you want to update.

```

Chan | 1 | 2 | 3 | 4 | 5 | 6 | 7 | 8 |
-----|---|---|---|---|---|---|---|---|
Prot | X.28 | X.28 | X.28 | SLIP | X.28 | X.28 | X.28 | X.28 |

Enter channel number to set:

```

3. In the SLIP x Configuration menu, choose **1** (Speed).

```

SLIP 4 Configuration
-----
1) Speed ..... [ 14]
2) Flow control options ..... [ 0]
3) Stop bits ..... [ 0]
4) Bits / char ..... [ 3]
5) Parity ..... [ 0]
S) Save.
CR) Exit.

Select:

```

4. In the Speed menu, choose the option number according to the data rate of the port connected to this channel.

```

1) Speed
-----

Current value ... [14 ]

Possible values:
0 - 110 bits/s
2 - 300 bits/s
3 - 1200 bits/s
4 - 600 bits/s
5 - 75 bits/s
6 - 150 bits/s
12 - 2400 bits/s
13 - 4800 bits/s
14 - 9600 bits/s
15 - 19.2 Kbits/s
19 - 38.4 Kbits/s
20 - 57.6 Kbits/s
21 - 115.2 Kbits/s

Enter one of the above values or <RETURN> to exit:

```



5. In the SLIP x Configuration menu, change other channel parameters according to your specifications or keep their default values. Choose **S** to save the configuration.

► **Configure IP interfaces**

In this application, configure two IP interfaces, one for the SLIP connection and the other for the X.25 connection.

SLIP connection

1. Press ENTER several times so that the Configuration menu reappears. In the Configuration menu, choose **14** (IP Configuration).

```
Configuration menu
-----
1) Channel
2) Profile
3) Link
4) System parameters
5) PVC
6) Call ID
7) NUI
8) Alias
9) Routing table
10) Funnel
11) X.32
12) Management
13) Multicast
14) IP configuration
15) ISDN configuration
16) SNA
CR) Exit

Select:
```

2. In the IP Configuration menu, choose **2** (IP Interface).

```
IP Configuration
-----
1) IP global parameters.
2) IP interface.
3) IP static route.
CR) Exit

Select:
```

3. In the IP Interface Configuration menu, choose **4** (Display IP Interface Entry).

```
IP Interface Configuration
-----
1) Add IP Interface Entry.
2) Delete IP Interface Entry.
3) Update IP Interface Entry.
4) Display IP Interface Entry.
CR) Exit.

Select:
```

Make a note of the IP interface entry for the SLIP destination and press ENTER.

4. In the IP Interface Configuration menu, choose **3** (Update IP Interface Entry).

```

IP Interface Configuration
-----
1) Add IP Interface Entry.
2) Delete IP Interface Entry.
3) Update IP Interface Entry.
4) Display IP Interface Entry.
CR) Exit.

Select:

```

Type the IP Interface you made note of in the previous step.

5. In the IP Interface x Configuration menu, set the IP Address (option **1**) and the IP Mask (option **2**) of the equipment connected to the SLIP channel..

```

IP Interface 1      Configuration
-----
1) IP address ..... [0.0.0.0]
2) IP mask ..... [255.255.255.255]
3) RIP mode ..... [ 0 ]
4) Destination ..... [No Destination]
5) Default route metric ..... [Disabled]
6) Inactivity timer ..... [ ]
7) Link cost ..... [ 1 ]
8) Options ..... [ 0 ]
S) Save.
CR) Exit.

Select:

```

6. In the IP Interface x Configuration menu, choose **1** (IP Address). In the IP Address screen, type the IP address of the equipment connected to this channel.

```

1) IP address
-----
Current value ... [0.0.0.0]

Possible values:
A string of the format: X.X.X.X
Where every X is a number in the range 0 - 255.

Enter one of the above values or <RETURN> to exit:

```

7. In the IP Interface x Configuration menu, choose **2** (IP Mask). In the IP Mask screen, type **255.255.255.255** (no mask).

```

2) IP mask
-----
Current value ... [0.0.0.0]

Possible values:
A string of the format: X.X.X.X
Where every X is a number in the range 0 - 255.

Enter one of the above values or <RETURN> to exit:

```

8. Change other IP interface parameters according to your specifications or keep their default values. Choose **S** to save the configuration.

### X.25 connection

1. In the IP Interface Configuration menu, choose **1** (Add IP Interface Entry).

```

IP Interface Configuration
-----
1) Add IP Interface Entry.
2) Delete IP Interface Entry.
3) Update IP Interface Entry.
4) Display IP Interface Entry.
CR) Exit.

Select:

```

Type a new IP Interface number for the X.25 connection.

2. In the IP Interface x Configuration menu, set the IP Address (option **1**) and the IP Mask (option **2**) to the specifications of the host computer destination.

```

IP Interface 1 Configuration
-----
1) IP address ..... [0.0.0.0]
2) IP mask ..... [255.255.255.255]
3) RIP mode ..... [ 0 ]
4) Destination ..... [No Destination]
5) Default route metric ..... [Disabled]
6) Inactivity timer ..... [ ]
7) Link cost ..... [ 1 ]
8) Options ..... [ 0 ]
S) Save.
CR) Exit.

Select:

```

3. In the IP Interface x Configuration menu, choose **4** (Destination). Set the destination to **X.25 SVC** using the host computer X.25 address.

```

4) Destination
-----
Current value ... [No Destination]

Possible values:
No Destination: 'N'
X.25 PVC      : Port:LCN
X.25 SVC      : X25 Addr or 'cid' followed by a predefined call ID number
Frame Relay   : Port:DLCI
HDLC          : 'H' followed by the HDLC port number
SLIP          : 'S' followed by the SLIP port number
PPP           : 'P' followed by the PPP port number
BUNDLE        : 'B' followed by the PPP Bundle number
Ethernet      : 'E' followed by the Ethernet port number

Enter one of the above values or <RETURN> to exit:

```

4. Choose **S** to save the configuration.

### ► **Configure X.25 routing table entry**

- See *X.25 Link Configuration, "Terminal Configuration Procedures, ► Add a routing table entry."* Perform all steps as instructed.

## 2.5 SLIP to Frame Relay

Transferring data through a SLIP channel over a Frame Relay network.

This section describes configuration procedures of a packet switching device in a SLIP to Frame Relay application. These procedures include:

- Set a link to Frame Relay
- Set the Frame Relay port parameters
- Set a channel to SLIP
- Set the SLIP channel parameters
- Configure the IP interfaces.

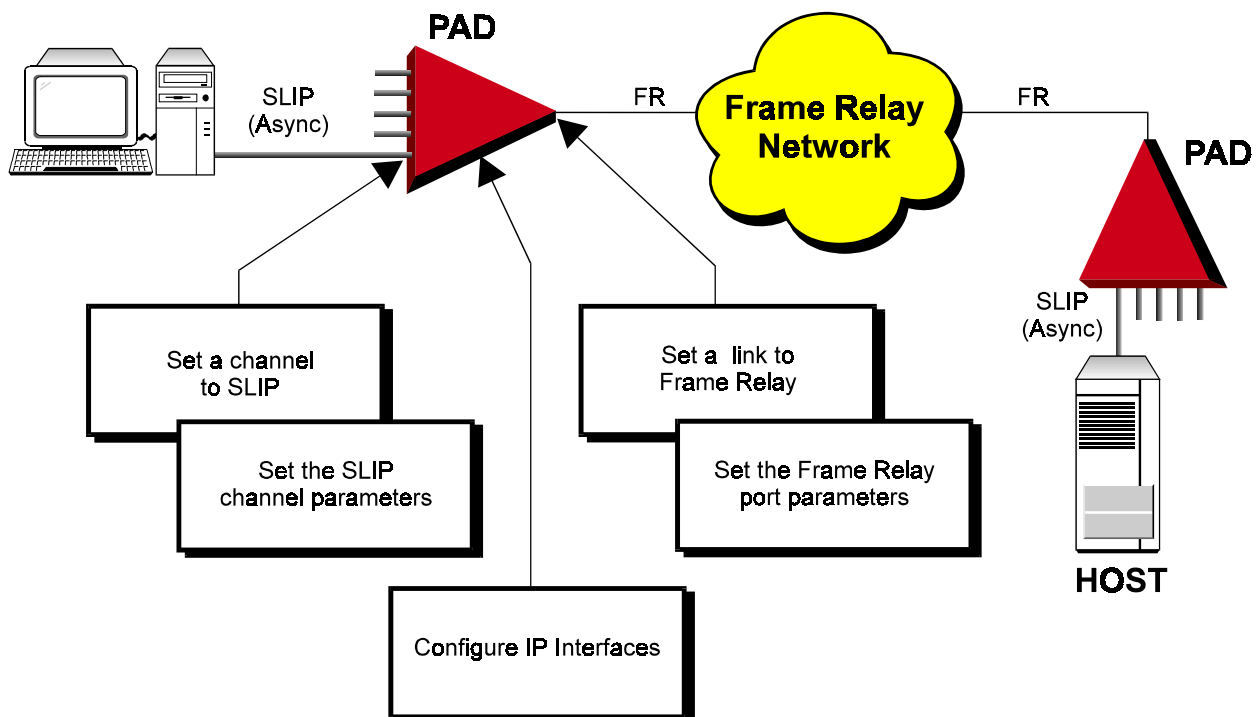

## Terminal Configuration Procedures



- **Set a link to Frame Relay**
  - See *Frame Relay Link Configuration, "Terminal Configuration Procedures, ➤ Set a link to Frame Relay."* Perform all steps as instructed.
- **Set the Frame Relay port parameters**
  - See *Frame Relay Link Configuration, "Terminal Configuration Procedures, ➤ Set the Frame Relay port parameters."* Perform all steps as instructed.
- **Set a channel to SLIP**

See *SLIP to X.25, "➤ Set a channel to SLIP."* Perform all steps as instructed.
- **Set the SLIP channel parameters**

See *SLIP to X.25 "➤ Set the SLIP channel parameters."* Perform all steps as instructed.
- **Configure the IP interfaces**

In this application, configure two IP interfaces, one for the SLIP connection and the other to the Frame Relay connection.

### SLIP Connection

See *SLIP to X.25, "➤ Configure the IP interfaces."* Perform steps 1 to 8 as instructed.

### Frame Relay connection

1. In the IP Interface Configuration menu, choose **1** (Add IP Interface Entry).

```

IP Interface Configuration
-----
1) Add IP Interface Entry.
2) Delete IP Interface Entry.
3) Update IP Interface Entry.
4) Display IP Interface Entry.
CR) Exit.

Select:

```

Type a new IP Interface number for the Frame Relay connection.

- In the IP Interface x Configuration menu, set the IP Address (option **1**) and the IP Mask (option **2**) to the specifications of the host computer destination.

```

IP Interface 1      Configuration
-----
1) IP address ..... [0.0.0.0]
2) IP mask ..... [255.255.255.255]
3) RIP mode ..... [ 0 ]
4) Destination ..... [No Destination]
5) Default route metric ..... [Disabled]
6) Inactivity timer ..... [ ]
7) Link cost ..... [ 1 ]
8) Options ..... [ 0 ]
S) Save.
CR) Exit.

Select:

```

- In the IP Interface x Configuration menu, choose **4** (Destination). Set the destination to **Frame Relay** using the Port:DLCI according to Frame Relay network specifications.

```

4) Destination
-----
Current value ... [No Destination]

Possible values:
No Destination: 'N'
X.25 PVC   :   Port:LCN
X.25 SVC   :   X25 Addr or 'cid' followed by a predefined call ID number
Frame Relay: Port:DLCI
HDLC       :   'H' followed by the HDLC port number
SLIP       :   'S' followed by the SLIP port number
PPP        :   'P' followed by the PPP port number
BUNDLE     :   'B' followed by the PPP Bundle number
Ethernet   :   'E' followed by the Ethernet port number

Enter one of the above values or <RETURN> to exit:

```

- Choose **S** to save the configuration.

## 2.6 Asynchronous PPP

Providing Point-to-Point connectivity from local host and client to an external network. This application is commonly used to provide access to an Internet Service Provider (ISP) at a remote location.

This section describes configuration procedures of two packet switching devices in an Asynchronous PPP application. These procedures include:

- Set a channel to PPP - PS 1
- Set the PPP channel parameters - PS 1
- Set a channel to PPP - PS 2
- Set the PPP channel parameters - PS 2
- Set security parameters for the PS 2
- Configure the IP interface for PS1 and PS2.

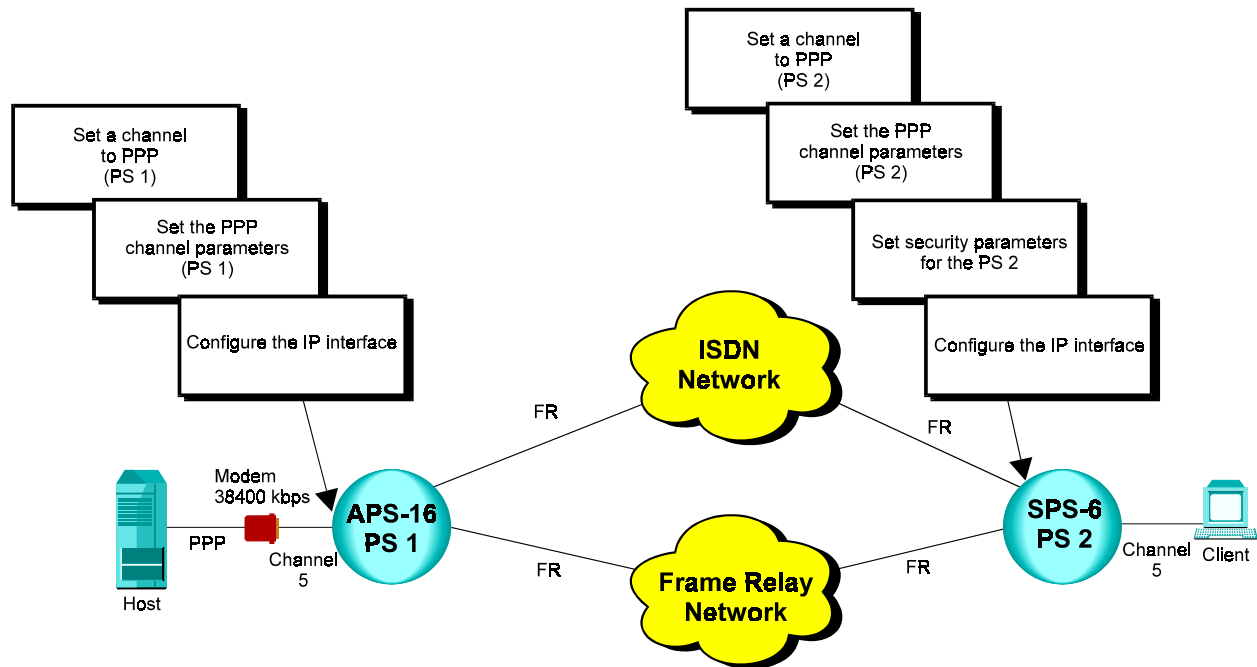

## Terminal Configuration Procedures



The following section describes terminal configuration procedures for an Asynchronous PPP application.

### ► Set a channel to PPP - PS 1

1. Connect the setup terminal to the packet switching PS 1 device (APS-16) and load the Packet Switch command facility.
2. In the Configuration menu, choose **1** (Channel).

►

```

Configuration menu
-----
1) Channel
2) Profile
3) Link
4) System parameters
5) PVC
6) Call ID
7) NUI
8) Alias
9) Routing table
10) Funnel
11) X.32
12) Management
13) Multicast
14) IP configuration
15) ISDN configuration
16) SNA
CR) Exit

Select:
  
```

3. In the Channel Configuration menu, choose **5** (Set Channel Type).

►

```

Channel configuration
-----
1) Duplicate channel
2) Duplicate channel with mask
3) Update channel
4) Display channels
5) Set Channel Type
CR) Exit

select:
  
```

4. Choose the number of the channel that you want to set to PPP protocol.

►

Chan	1	2	3	4	5	6	7	8
Prot	X.28	X.28	X.28	X.28	X.28	X.28	X.28	X.28

Enter channel number to set:



5. In the Channel Protocol Types menu, choose **3** (PPP).

```

Channel Protocol Types
-----
1) X.28
2) Slip
3) PPP
CR) Exit

select:

```

A warning appears stating that this action will set this PPP channel's parameters to their default values. Choose **Y** to continue.

➤ **Set the PPP channel parameters - APS-16 PS 1**

1. Press ENTER several times so that the Channel Configuration menu reappears. In the Channel Configuration menu, choose **3** (Update Channel).

```

Channel configuration
-----
1) Duplicate channel
2) Duplicate channel with mask
3) Update channel
4) Display channels
5) Set Channel Type
CR) Exit

select:

```

2. Choose the number of the PPP channel that you want to update.

```

Chan | 1 | 2 | 3 | 4 | 5 | 6 | 7 | 8 |
-----|---|---|---|---|---|---|---|---|
Prot | X.28 | X.28 | X.28 | X.28 | PPP | X.28 | X.28 | X.28 |

Enter channel number to set:

```

3. In the PPP x Configuration menu, choose **1** (Speed).

```

PPP 5 Configuration
-----
1) Speed ..... [ 14 ]    6) Signal Check ..... [ 0 ]
2) Flow control .... [ 0 ]  7) Link Alive Time ..... [ 0 ]
3) Stop bits ..... [ 0 ]   8) MRU ..... [ 1500 ]
4) Bits / char .... [ 3 ]   9) ACCM ..... [ ]
5) Parity ..... [ 0 ]

Port authentication
-----
10) Port Authentication type ..... [ 0 ]
11) Port User name ..... [ ]
12) Port Password ..... [ ]

S) Save.
CR) Exit.

Select:

```

4. In the Speed menu, choose the option number according to the data rate of the port connected to this channel.

```
1) Speed
-----

Current value ... [14  ]

Possible values:
0 - 110  bits/s
2 - 300  bits/s
3 - 1200 bits/s
4 - 600  bits/s
5 - 75   bits/s
6 - 150  bits/s
12 - 2400 bits/s
13 - 4800 bits/s
14 - 9600 bits/s
15 - 19.2 Kbits/s
19 - 38.4 Kbits/s
20 - 57.6 Kbits/s
21 - 115.2 Kbits/s

▶ Enter one of the above values or <RETURN> to exit:
```

5. In the PPP x Configuration menu, change other channel parameters according to your specifications or keep their default values. Choose **S** to save the configuration.

▶ **Set a channel to PPP - PS 2**

1. Connect the setup terminal to the packet switching PS 2 device (SPS-6) and load the Packet Switch command facility.
- See the procedure, “▶ *Set a channel to PPP - PS 1*,” earlier in this section. Perform steps 2 to 5 of the procedure.

➤ **Set the PPP channel parameters - PS 2**

- See the procedure, “➤ *Set the PPP channel parameters - PS 1,*” earlier in this section. Perform steps 1 to 5 of the procedure. Afterwards, perform the following steps:

1. In the PPP x Configuration menu, choose **10** (Port Authentication Type). Choose **1** (PAP or CHAP authentication as host) to enable PAP/CHAP security functions in the host packet switch.

```

10)  Port Authentication Type
-----
Current value ... [ 0 ]

0 - No authentication. The port performs the user side only.
1 - PAP or CHAP authentication as host.
2 - CHAP authentication as host.

Note : In order to use authentication as host (option 1 or 2),
       PAP/CHAP authentication table must be configured.
       This can be done in the SYSTEM PARAMETERS screens.

Enter one of the above values or <RETURN> to exit:

```

2. In the PPP x Configuration menu, choose **11** (Port User Name). In the Port User Name screen, type the name that is used for the port's identification during negotiation with connected equipment.

```

11)  Port User Name
-----
Current value ... [                ]

Alphanumeric characters. Maximum 20 characters.
In order to erase the field, enter <SPACE>.

Enter one of the above values or <RETURN> to exit:

```

3. In the PPP x Configuration menu, choose **12** (Port Password). In the Port Password screen, type the password that is used for the port's identification during negotiation with connected equipment.

```

12)  Port Password
-----
Current value ... [                ]

Alphanumeric characters. Maximum 20 characters.
In order to erase the field, enter <SPACE>.

Enter one of the above values or <RETURN> to exit:

```

4. In the PPP x Configuration menu, change other channel parameters according to your specifications or keep their default values. Choose **S** to save the configuration.

➤ **Set security parameters for the PS 2**

1. Press ENTER several times so that the Configuration menu reappears. In the Configuration menu, choose **4** (System Parameters).

```
Configuration menu
-----
1) Channel
2) Profile
3) Link
4) System parameters
5) PVC
6) Call ID
7) NUI
8) Alias
9) Routing table
10) Funnel
11) X.32
12) Management
13) Multicast
14) IP configuration
15) ISDN configuration
16) SNA
CR) Exit

Select:
```

2. In the System Configuration menu, choose **4** (PAP/CHAP Configuration Table).

```
System Configuration
-----
1. System Parameters
2. Priority Parameters
3. Ethernet Global Parameters
4. PAP/CHAP Configuration Table
CR) Exit

Select:
```

3. In the PAP/CHAP Authentication Table menu, select **1** (Add PAP/CHAP Authentication Entry).

```
PAP/CHAP Authentication Table
-----
1) Add PAP/CHAP Authentication Entry.
2) Delete PAP/CHAP Authentication Entry.
3) Update PAP/CHAP Authentication Entry.
4) Display PAP/CHAP Authentication Entry.
CR) Exit.

Select:
```

Type a number for the new entry (**1** to **200**).

- In the PAP/CHAP x Authentication Entry menu, choose **1** (User Name) and type the client/terminal user name.

```

PAP/CHAP  1  Authentication Entry
-----
1) User Name .....[                ]
2) Password  .....[                ]

S) Save.
CR) Exit.

Select:

```

- In the PAP/CHAP x Authentication Entry menu, choose **2** (Password) and type a password. This password is used to authenticate the clients that are connected to PS 2 only.

**Note** You can define more than one user password to allow different passwords for different clients. You can view the passwords list in PAP/CHAP x Authentication table.

- In the PAP/CHAP x Authentication Entry menu, choose **S** to save the configuration.

➤ **Add IP interface routing entries for both PS devices**

**Note** Perform the following procedure identically for both devices in this application.

After the channel was defined as PPP, the device automatically created a new interface for the PPP channel. This interface's number is **101**.

- Press ENTER several times so that the Configuration menu reappears. In the Configuration menu, choose **14** (IP Configuration).

```

Configuration menu
-----
1) Channel
2) Profile
3) Link
4) System parameters
5) PVC
6) Call ID
7) NUI
8) Alias
9) Routing table
10) Funnel
11) X.32
12) Management
13) Multicast
14) IP configuration
15) ISDN configuration
16) SNA
CR) Exit

Select:

```

2. In the IP Configuration menu, choose **2** (IP Interface).

```

IP Configuration
-----
1) IP global parameters.
2) IP interface.
3) IP static route.
CR) Exit

Select:
  
```

3. In the IP Interface Configuration menu, choose **4** (Display IP Interface Entry).

```

IP Interface Configuration
-----
1) Add IP Interface Entry.
2) Delete IP Interface Entry.
3) Update IP Interface Entry.
4) Display IP Interface Entry.
CR) Exit.

Select:
  
```

Make a note of the IP interface entry for the PPP destination and press ENTER.

4. In the IP Interface Configuration menu, choose **3** (Update IP Interface Entry).

```

IP Interface Configuration
-----
1) Add IP Interface Entry.
2) Delete IP Interface Entry.
3) Update IP Interface Entry.
4) Display IP Interface Entry.
CR) Exit.

Select:
  
```

Type the IP Interface you made note of in the previous step.

5. In the IP Address screen, type the IP address of the equipment connected to this channel.

```

1) IP address
-----
Current value ... [0.0.0.0]

Possible values:
A string of the format: X.X.X.X
Where every X is a number in the range 0 - 255.

Enter one of the above values or <RETURN> to exit:
  
```

6. Change other IP interface parameters according to your specifications or keep their default values. Choose **S** to save the configuration.

---

---

## 2.7 Multilink PPP - Bandwidth on Demand

Transferring data over more than one Point-to-Point (PPP) link between two packet switching devices.

The transmitting device splits the data among a set of links called a bundle. In this application, one line directly connects between synchronous PPP links of two packet switching devices. The second line is routed through an ISDN network. If the amount of buffers waiting to be transferred exceeds the capacity of the synchronous PPP link(s), the device initiates an ISDN call and adds the ISDN link to the bundle.

This section describes configuration procedures of two packet switching devices in an Multilink Synchronous PPP application. These procedures include:

- Set two links to PPP (PS1)
- Set the Link 1 and Link 4 PPP parameters (PS1)
- Add PS1's IP interface entry
- Set two links to PPP (PS2)
- Set the Link 3 and Link 6 PPP parameters (PS2)
- Set the ISDN line parameters for PS1 and PS2

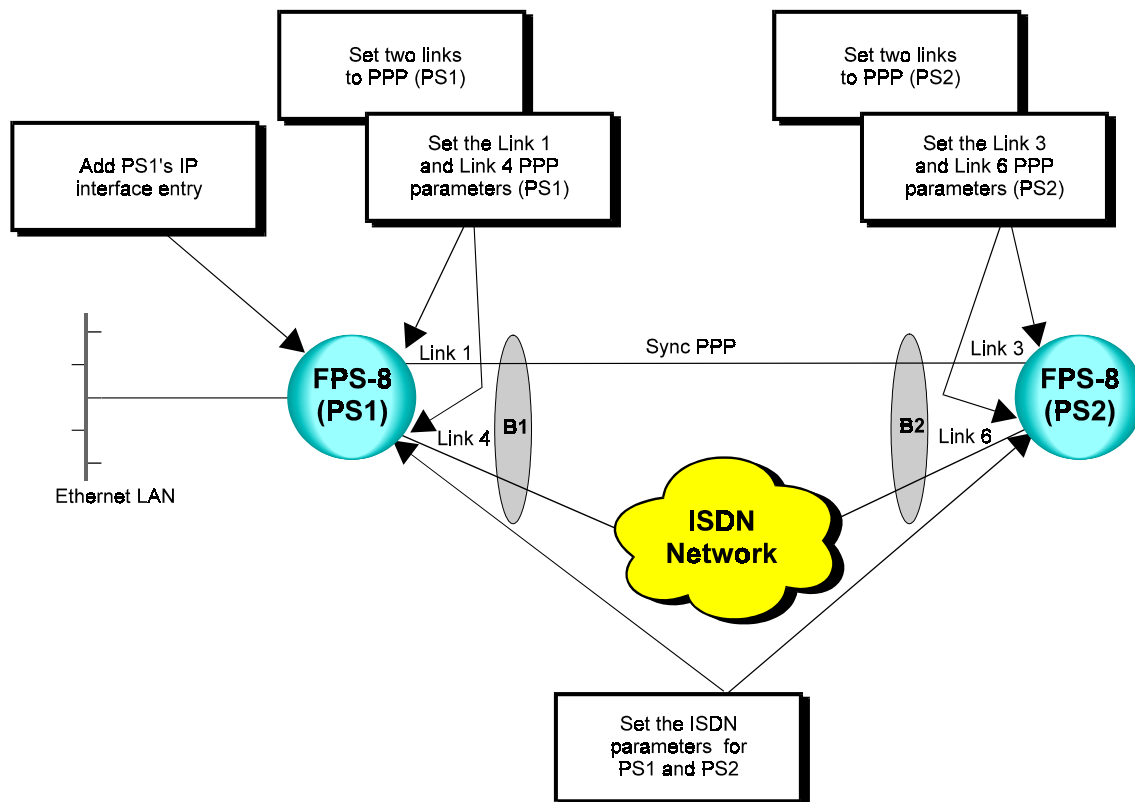

## Terminal Configuration Procedures



The following section describes terminal configuration procedures for an Multilink PPP application.

### ➤ Set two links to PPP (PS1)

1. Connect the setup terminal to PS1 and load the Packet Switch command facility.
2. In the Configuration menu, choose **3** (Link).

```

Configuration menu
-----
1) Channel
2) Profile
3) Link
4) System parameters
5) PVC
6) Call ID
7) NUI
8) Alias
9) Routing table
10) Funnel
11) X.32
12) Management
13) Multicast
14) IP configuration
15) ISDN configuration
16) SNA
CR) Exit

Select:

```



3. In the Link Configuration menu, choose **1** (Set Link Type).

```

Link configuration
-----
1) Set Link type.
2) Display Links protocols.
3) Update Link parameters.
4) Display Links parameters.
CR) Exit

Select:

```

4. Choose the number of the link that you want to set to PPP protocol (link **1**).

```

Link | 1 | 2 | 3 | 4 | 5 | 6 | 7 | 8 |
-----|-----|-----|-----|-----|-----|-----|-----|
Prot | X.25 | X.25 | X.25 | X.25 | X.25 | X.25 | X.25 | X.25 |

Enter Link number to set:

```

5. In the Link Types menu, choose **12** (PPP).

```

Link types
-----
1) X.25
2) FRAME RELAY
3) HDLC
4) SDLC
5) ASYNC
6) STM4/4HS
7) STM8/8HS
8) STM16/16HS
9) STM24/24HS
10) MPE (Multi Point Encapsulator)
11) ETHERNET
12) PPP
CR) Exit

Select:

```

A warning appears stating that this action will set this PPP link's parameters to their default values. Choose **Y** to continue.

6. Press ENTER several times so that the Link Configuration appears. To set another link (link 4) to PPP, repeat steps 3 to 5 of this procedure.

➤ **Set the Link 1 and Link 4 PPP parameters (PS1)**

1. Press ENTER several times so that the Link Configuration menu reappears. In the Link Configuration menu, choose **3** (Update Link Parameters).

```

Link configuration
-----
1) Set Link type.
2) Display Links protocols.
3) Update Link parameters.
4) Display Links parameters.
CR) Exit

Select:

```

2. Choose the number of the PPP link that you want to update (Link 1).

Chan	1	2	3	4	5	6	7	8
Prot	PPP	X.28	X.28	PPP	X.28	X.28	X.28	X.28

Enter channel number to set:

3. In the PPP Link x Configuration menu, choose **1** (Attach to Bundle).

```

PPP Link 1 Configuration
-----
ML PPP parameters
 1) Attach to Bundle ..... [ 0 ]

LCP parameters
 2) MRU ..... [1500 ]

Port authentication
 3) Port Authentication type ..... [ 0 ]
 4) Port User name ..... [
 5) Port Password ..... [

Physical Parameters
 6) Internal Clock ..... [ 0 ]
 7) Signal Check ..... [ 3 ]
 8) ISDN Destination ..... [ 0 ]

S) Save.
CR) Exit.

Select:

```

4. In the Attach to Bundle screen, type **1** to attach this link to Bundle 1 (B1).

```

 1) Attach to Bundle
-----
Current value ... [ 0 ]
-----
Bundles list | Attached links
-----
|
|
|
|
|
|
-----
Possible values:
 0 - do not attach to bundle.
 1..255 - Attach to Bundle number.

Enter one of the above values or <RETURN> to exit:

```

5. In the PPP x Configuration menu, change other channel parameters according to your specifications or keep their default values. Choose **S** to save the configuration.
6. To configure the PPP link 4, repeat steps 1 to 6.

➤ **Add PS1's IP interface entry**

1. Press ENTER several times so that the Configuration menu reappears. In the Configuration menu, choose **14** (IP Configuration).

```
Configuration menu
-----
1) Channel
2) Profile
3) Link
4) System parameters
5) PVC
6) Call ID
7) NUI
8) Alias
9) Routing table
10) Funnel
11) X.32
12) Management
13) Multicast
14) IP configuration
15) ISDN configuration
16) SNA
CR) Exit

Select:
```

2. In the IP Configuration menu, choose **2** (IP Interface).

```
IP Configuration
-----
1) IP global parameters.
2) IP interface.
3) IP static route.
CR) Exit

Select:
```

3. In the IP Interface Configuration menu, choose **1** (Add IP Interface Entry).

```
IP Interface Configuration
-----
1) Add IP Interface Entry.
2) Delete IP Interface Entry.
3) Update IP Interface Entry.
4) Display IP Interface Entry.
CR) Exit.

Select:
```

Type the number of the IP interface to add (**1 - 200**).

4. In the IP Interface x Configuration menu, choose **4** (Destination).

```

IP Interface 1      Configuration
-----
1) IP address ..... [0.0.0.0]
2) IP mask ..... [255.255.255.255]
3) RIP mode ..... [ 0 ]
4) Destination ..... [No Destination]
5) Default route metric ..... [Disabled]
6) Inactivity timer ..... [ ]
7) Link cost ..... [ 1 ]
8) Options ..... [ 0 ]
S) Save.
CR) Exit.

Select:

```

5. In the Destination screen, type **B1** to define Bundle 1 as the destination.

```

4) Destination
-----
Current value ... [No Destination]

Possible values:
No Destination: 'N'
X.25 PVC      :   Port:LCN
X.25 SVC      :   X25 Addr or 'cid' followed by a predefined Call ID number
Frame Relay   :   Port:DLCI
HDLC          :   'H' followed by the HDLC port number
SLIP          :   'S' followed by the SLIP port number
PPP           :   'P' followed by the PPP port number
BUNDLE        :   'B' followed by the PPP Bundle number
Ethernet      :   'E' followed by the Ethernet port number

Enter one of the above values or <RETURN> to exit:

```

6. In the IP Interface x Configuration menu, change other parameters according to your specifications or keep their default values. Choose **S** to save the configuration.

➤ **Set two links to PPP (PS2)**

1. Connect the setup terminal to PS2 and load the Packet Switch command facility.
  - See the procedure, "➤ *Set two links to PPP (PS1)*," earlier in this section. Perform steps 2 to 5 of the procedure for link 3. Perform step 6 of the procedure for link 6.

➤ **Set the Link 3 and Link 6 PPP parameters (PS2)**

1. Press ENTER several times so that the Link Configuration menu reappears. In the Link Configuration menu, choose **3** (Update Link Parameters).
2. Choose the number of the PPP link that you want to update (Link 3).

Chan	1	2	3	4	5	6	7	8
Prot	X.28	X.28	PPP	X.28	X.28	PPP	X.28	X.28

▶ Enter channel number to set:

3. In the PPP Link x Configuration menu, choose **1** (Attach to Bundle).
4. In the Attach to Bundle screen, type **2** to attach this link to Bundle 2 (B2).
5. In the PPP Link x Configuration menu, choose **6** (Internal Clock) because PS2 supplies the clock. In the Internal Clock screen, type the option number according to your specifications.
6. In the PPP x Configuration menu, change other channel parameters according to your specifications or keep their default values. Choose **S** to save the configuration.
7. To configure the PPP link 6, repeat steps 1 to 7.

➤ **Set the ISDN line parameters for PS1 and PS2**

In this application, link 3 of PS1 and link 6 of PS2 are connected to each other through an ISDN environment.

1. Press ENTER several times so that the Configuration menu appears. In the Configuration menu, choose **15** (ISDN Configuration).

▶

```

Configuration menu
-----
1) Channel
2) Profile
3) Link
4) System parameters
5) PVC
6) Call ID
7) NUI
8) Alias
9) Routing table
10) Funnel
11) X.32
12) Management
13) Multicast
14) IP configuration
15) ISDN configuration
16) SNA
CR) Exit

Select:

```

- In the ISDN Configuration menu, choose **4** (Update ISDN Link Parameters).

```

ISDN configuration
-----

1) Global Configuration.
2) ISDN Routing Table.
3) ISDN Accept List Table.
4) Update ISDN Link Parameters.
5) Display ISDN Link Parameters.
CR) Exit.

Select:

```

- Type **3** (for PS1) or **6** (for PS2) as the ISDN link number and press ENTER.

- In the ISDN Link x Configuration menu, choose **1** (ISDN Protocol Type).

```

ISDN link 3 configuration
-----

1) ISDN Protocol Type ..... [0  ]
2) ISDN Channel ..... [Not Used]
3) Calling Address ..... [  ]
4) Calling Subaddress ..... [  ]
5) SPID ..... [  ]
6) TEI ..... [0  ]
7) Options ..... [0  ]
S) Save.
CR) Exit.

Select:

```

- In the ISDN Protocol Type menu, choose one of the protocol type according to the existing network.

```

1) ISDN Protocol Type
-----

Configuration of this parameter automatically sets the value
to the corresponding parameter of the complementary link as
well.

Current value ... [0  ]

Possible values:
0 - ETSI
1 - NTT
2 - Leased
3 - 5 ESS
4 - National 1
5 - DMS 100
6 - 5 ESS PTP

Enter one of the above values or <RETURN> to exit:

```

For example, defining the link as a Leased Line makes option 2 (ISDN Channel) available.

6. In the ISDN Link x Configuration menu, choose **2** (ISDN Channel). In the ISDN Channel menu, choose **2** (B2 - Complementary with B1).

```

2) ISDN Channel
-----

This parameter determines the Bearer Channel of the ISDN link.
This parameter is relevant only when the ISDN Protocol Type
is defined as Leased line.
Only complementary values to the corresponding parameter in the
complementary ISDN link are accepted.

Current value ... [0  ]

Possible values:
  0 - No channel (Complementary with all channel values)
  1 - B1        (Complementary with B2)
  2 - B2        (Complementary with B1)
  3 - B1 and B2 (Complementary with No channel value)

Enter one of the above values or <RETURN> to exit:

```

7. Add ISDN routing entry x. See the procedure, "**►Set the ISDN routing parameters (SPS-6)**," in section 2.16. Perform steps 1 to 6 of the procedure.
8. In the ISDN Link x Configuration menu, choose **3** (Calling Address) and **4** (Calling Subaddress). Type the destination address and subaddress as configured in the ISDN Routing Entry x Configuration menu.
9. In the ISDN Link x Configuration menu, change other channel parameters according to your specifications or keep their default values. Choose **S** to save the configuration.
10. To configure ISDN link 6 of PS2, repeat steps 1 to 8 of this procedure.
11. In the Link Configuration menu, choose **3** (Update Link Parameters).

```

Link configuration
-----

1) Set Link type.
2) Display Links protocols.
3) Update Link parameters.
4) Display Links parameters.
CR) Exit

Select:

```

12. Choose the number of the PPP link that runs over the ISDN link.

```

Chan | 1 | 2 | 3 | 4 | 5 | 6 | 7 | 8 |
-----|---|---|---|---|---|---|---|---|
Prot | PPP | X.28 | X.28 | PPP | X.28 | X.28 | X.28 | X.28 |

Enter channel number to set:

```

13. In the PPP Link x Configuration menu, choose **8** (ISDN Destination) and update the ISDN routing entry.

```

PPP Link 1 Configuration
-----

ML PPP parameters
 1) Attach to Bundle ..... [ 0 ]

LCP parameters
 2) MRU ..... [1500 ]

Port authentication
 3) Port Authentication type ..... [ 0 ]
 4) Port User name ..... [
 5) Port Password ..... [

Physical Parameters
 6) Internal Clock ..... [ 0 ]
 7) Signal Check ..... [ 3 ]
 8) ISDN Destination ..... [ 0 ]

S) Save.
CR) Exit.

Select:

```

14. Reset both packet switching devices and wait for the devices to synchronize with each other.

➤ **To check the synchronization between PS1 and PS2 (option)**

1. After resetting both packet switching devices and wait for the devices to synchronize with each other.
2. To check that the links are functioning normally, send a Ping test from either of the devices.

In the Diagnostics menu, choose **2** (Send Ping).

```

DIAGNOSTICS MENU
-----

1) FOX test
2) Send Ping
3) Local Loopback
4) Remote Loopback
CR) Exit
Select:

```

3. In the Send Ping screen, choose **1** (Destination IP Address).

```

Send Ping Screen
-----

The source ip address is the AGENT IP address of the device.

1) Destination IP address ..... [
S) Start sending ping.

CR) Exit.

Select:

```

4. In the IP Address screen, type a valid IP address in the format X.X.X.X where X stands for a number from 0 to 255.
5. In the Send Ping screen, choose **S** to start the Ping test. If the connection is normal, confirmation appears on your terminal.
6. To stop the test, press ENTER.



## 2.8 X.25 to X.25

In a typical X.25 to X.25 application, a packet switch functions as an X.25 concentrator, providing access to an X.25 network.

This section describes configuration procedures of a packet switch in an X.25 to X.25 application. These procedures include:

- Select an X.25 link (Link 1) that connects to an X.25 network
- Set the Link 1 parameters
- Select an X.25 link (Link 2) that connects to a PAD
- Set the Link 2 parameters
- Add a routing table entry.

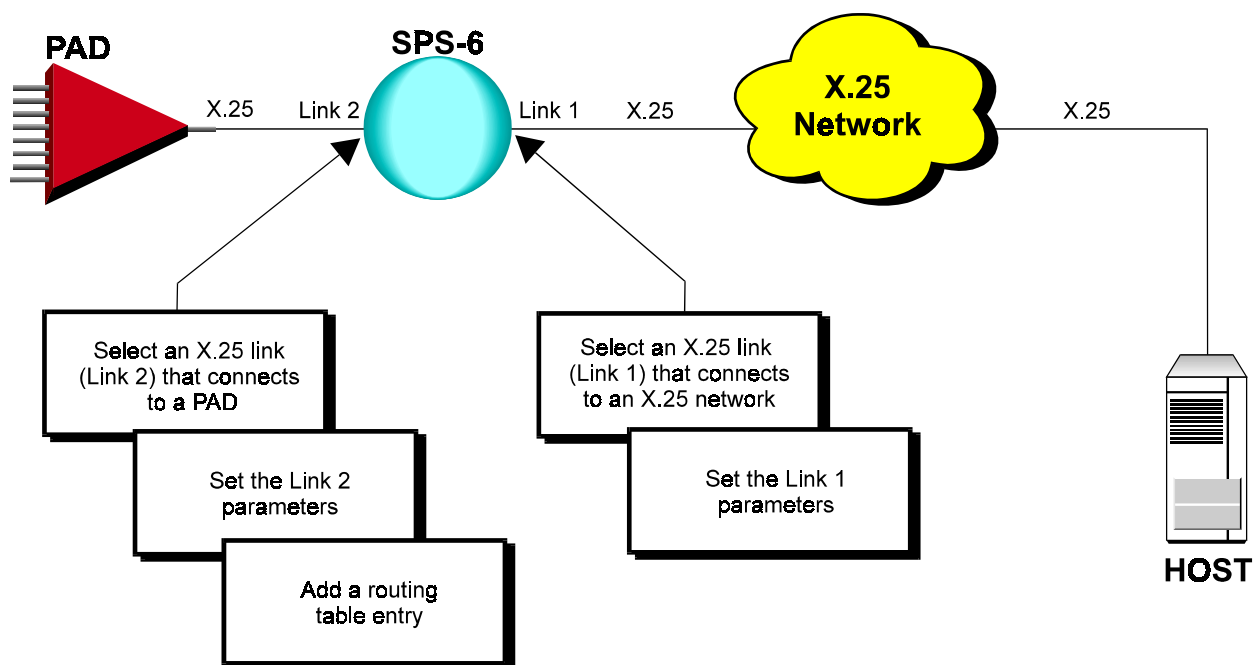

### Terminal Configuration Procedures



The following section describes terminal configuration procedures of a packet switch in an X.25 to X.25 application.

- **Select an X.25 link (Link 1) that connects to an X.25 network**
  - See *X.25 Link Configuration, "Terminal Configuration Procedures, ➤ Select an X.25 link."* Perform all steps as instructed.

► **Set the Link 1 parameters**

**Note** Verify that Link 1 is DTE.

1. In the Link x Configuration menu, choose **2** (DCE/DTE).

```

X.25 Link 1 configuration
-----
1) Address ..... [0 ] 17) LGN ..... [0 ]
2) DCE (1) / DTE (0)..... [1 ] 18) Lowest LCN (LIC) ..... [1 ]
3) Extended mode ..... [0 ] 19) Amount of Incoming LCNs .. [5 ]
4) T1 ..... [5 ] 20) Amount of Two Way LCNs ... [5 ]
5) T3 ..... [20 ] 21) Amount of Outgoing LCNs .. [5 ]
6) N2 ..... [10 ] 22) Internal Clock ..... [0 ]
7) k ..... [7 ] 23) LINE option ..... [1024 ]
8) w ..... [2 ] 24) Segment Size..... [128 ]
9) T10 ..... [18 ] 25) Xid num ..... [0 ]
10) T11 ..... [20 ] 26) NUI Group ID ..... [0 ]
11) T12 ..... [18 ] 27) Physical interface option. [0 ]
12) T13 ..... [18 ] 28) X.25 Acknowledge Counter . [1 ]
13) Packet size ..... [128 ] 29) X.25 Acknowledge Timer ... [0 ]
14) In call options ..... [1 ] 30) LAPB Acknowledge Counter . [1 ]
15) Out call options ..... [1 ] 31) LAPB Acknowledge Timer ... [0 ]
16) Subaddress length ..... [2 ] 32) CUG subscription ..... [5 ]
S) Save
CR) Exit

Select:

```

2. In the DCE/DTE screen, choose **0** (X.25 DTE).

```

2) DCE/DTE
-----
Current value ... [1 ]

Possible values:
0 - The link appears as a X25 DTE.
1 - The link appears as a X25 DCE.
2 - The link is X25->DCE and LAPB->DTE.
3 - The link is X25->DTE and LAPB->DCE.

Enter one of the above values or <RETURN> to exit:

```

3. In the Link x Configuration menu, choose **8** (W). In the W screen, type the same value as the X.25 network's W value.

```

8) w
-----
Packet window size.
Current value ... [2 ]

Possible values:
1 - 7 : for operation in basic mode.
1 - 127 : for operation in extended mode.

Enter one of the above values or <RETURN> to exit:

```

- In the Link x Configuration menu, choose **13** (Packet Size). In the Packet Size screen, choose the same value as the X.25 network's Packet Size value.

```
13) Packet size
-----
Current value ... [128 ]

Possible values:
0 - 4096
frequent values are:
128,256,512,1024,2048,4096

Enter one of the above values or <RETURN> to exit:
```

- In the Link x Configuration menu, choose **S** to save the configuration.

► **Select an X.25 link (Link 2) that connects to a PAD**

- See *X.25 Link Configuration, "Terminal Configuration Procedures, ► Select an X.25 link."* Perform all steps as instructed.

► **Set the Link 2 parameters**

**Note** Verify that Link 2 is DCE.

- In the Link x Configuration menu, choose **2** (DCE/DTE). In the DCE/DTE screen, choose **1** (X.25 DCE).

```
2) DCE/DTE
-----
Current value ... [1 ]

Possible values:
0 - The link appears as a X25 DTE.
1 - The link appears as a X25 DCE.
2 - The link is X25->DCE and LAPB->DTE.
3 - The link is X25->DTE and LAPB->DCE.

Enter one of the above values or <RETURN> to exit:
```

- In the Link *x* Configuration menu, choose **22** (Internal Clock) to set the baud rate of the link. In the Internal Clock menu, choose the option number according to your specifications.

```

22) Internal Clock
-----
Current value ... [0  ]

Possible values:

0 - External clock

Internal Clock
-----
1 - 2.4 Kbps      10 - 128 Kbps
2 - 4.8 Kbps      11 - 256 Kbps
3 - 9.6 Kbps      12 - 384 Kbps
4 - 14.4 Kbps     13 - 512 Kbps
5 - 19.2 Kbps     14 - 768 Kbps
6 - 38.4 Kbps     15 - 1008 Kbps
7 - 48 Kbps       16 - 1466 Kbps
8 - 56 Kbps       17 - 2016 Kbps
9 - 64 Kbps

Enter one of the above values or <RETURN> to exit:

```

- In the Link *x* Configuration menu, change other parameters according to your specifications or keep their default values. Choose **S** to save the configuration.

➤ **Add a routing table entry**

In this application, the routing goes from link 2 (PAD) to link 1 (X.25 network and destination host).

- See *X.25 Link Configuration, "Terminal Configuration Procedures, ➤ Add a routing table entry."* Perform steps 1 to 3 of the procedure. Afterwards, perform the following steps:

- The Destination Link screen, type 1 as the valid X.25 link number.

```

1) Destination link

Current value ... [1  ]

Possible values:
L - local channel.
Any valid X.25 link number.
Any valid FRAME RELAY DLCI with an X.25 destination protocol,
the DLCI is presented in the form of {port:DLCI}
ISDN routing entry number preceded by the letter 'I' (i.e.: I5)

Enter one of the above values or <RETURN> to exit:

```

- In the Routing Table Entry x Configuration menu, choose **4** (Address). In the Address screen, type the address of the destination host.

```

4) Address
-----
Current value ... [      ]

Possible values:
Up to 15 decimal digits or X (don't care) digits.

Enter one of the above values or <RETURN> to exit:

```

- In the Routing Table Entry x Configuration menu, choose **S** to save the configuration.

## RADview Configuration Procedures



The following section describes RADview configuration procedures of a packet switch in an X.25 to X.25 application.

➤ **Select an X.25 link (Link 1) that connects to an X.25 network**

- See *X.25 Link Configuration, "RADview Configuration Procedures, ➤ Select an X.25 link."* Perform all steps as instructed.

➤ **Set the Link 1 parameters**

**Note** Verify that Link 1 is DTE.

- In the PS View window, double-click the X.25 link. The X.25 window appears.

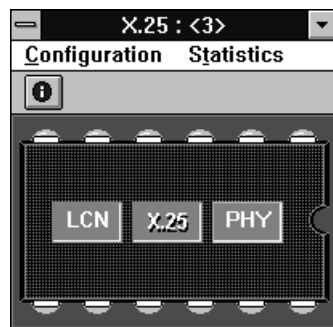

- In the X.25 window, click **X.25**. On the X.25 **Configuration** menu, point to **Parameters** and click **Quick Config**. In the X.25 Quick Config dialog box, click **Scratch** to switch to the Scratch configuration mode.

**SPS-6[S]: Quick Config**

Index: 1

Local Address: 0

DCE-DTE: DCE

Extended Mode: mod8

K: 7

W: 2

Packet Size: 128

LIC: 1

Incoming LCNs: 5

Two-way LCNs: 5

Outgoing LCNs: 5

Internal Clock (bps): 0

Set Cancel Active

- In the DCE/DTE list, click **DTE**. Click **Set**.
- Exit the X.25 window and return to the PS View without clicking a link. On the **Configuration** menu, point to **Sync Global Param**, then **Call Definition** and click **X.25 Call Parameters**.

**sps6/79: X.25 Call Parameters**

Index:	Reference Count:	Packet Size(byte):	W:	Accept Reverse Charge:
1	12	128	2	Refuse

Add... Save Done Refresh

- In the X.25 Call Parameters table, click **Add**.

**Add: X.25 Call Parameters**

Index: 2

Reference Count: 0

Packet Size (byte): 128

W: 2

Accept Reverse Charge: Refuse

Set Cancel

6. In the Add X.25 Call Parameters dialog box, set the same Packet Size and W values as those of the X.25 network. Click **Set**.
7. In the X.25 Call Parameters table, click **Refresh** to display the new set of parameters in the table.

➤ **Select an X.25 link (Link 2) that connects to a PAD**

- See *X.25 Link Configuration, "RADview Configuration Procedures, ➤ Select an X.25 link."* Perform all steps as instructed.

➤ **Set the Link 2 parameters**

**Note**

Verify that Link 2 is DCE.

1. In the PS View window, double-click the X.25 link. In the X.25 window, click **X.25**. On the X.25 **Configuration** menu, point to **Parameters** and click **Quick Config**. In the X.25 Quick Config dialog box, click **Scratch** to switch to the Scratch configuration mode.

The screenshot shows a dialog box titled "SPS-6[S]: Quick Config". It contains the following fields and values:

Index:	2
Local Address:	0
DCE-DTE:	DCE
Extended Mode:	mod8
K:	7
W:	2
Packet Size:	128
LIC:	1
Incoming LCNs:	0
Two-way LCNs:	20
Outgoing LCNs:	0
Internal Clock (bps):	9600

At the bottom of the dialog box are three buttons: "Set", "Cancel", and "Active".

2. In the DCE/DTE list, click **DCE**.
3. In the Internal Clock list, click the baud rate according to your specifications.
4. Change other link parameters according to your specifications or keep their default values. Click **Set**.

➤ **Add a routing table entry**

In this application, the routing goes from link 2 (PAD) to link 1 (X.25 network and destination host).

- See *X.25 Link Configuration, "RADview Configuration Procedures, ➤ Add a routing table entry."* Perform steps 1 and 2 of the procedure. Afterwards, perform the following steps:

1. In the Add Routing Table dialog box, click the Address box and type the address of the destination host.

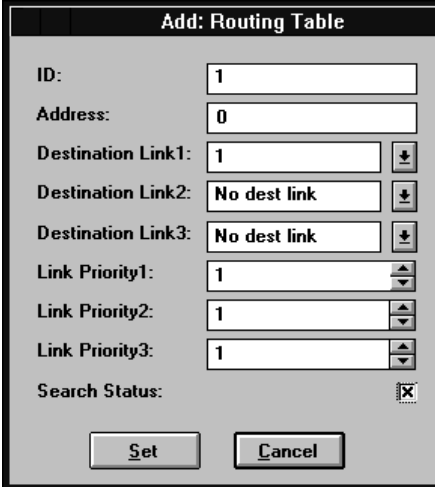

The screenshot shows a dialog box titled "Add: Routing Table". It contains the following fields and controls:

- ID:** A text input field containing the number "1".
- Address:** A text input field containing the number "0".
- Destination Link1:** A dropdown menu with "1" selected.
- Destination Link2:** A dropdown menu with "No dest link" selected.
- Destination Link3:** A dropdown menu with "No dest link" selected.
- Link Priority1:** A spin box with "1" selected.
- Link Priority2:** A spin box with "1" selected.
- Link Priority3:** A spin box with "1" selected.
- Search Status:** A checkbox that is checked.
- At the bottom, there are two buttons: "Set" and "Cancel".

2. In the Destination Link 1 list, click **1**.
3. In the Link Priority 1 list, click the number of calls to be routed through this link before calls are routed to backup links. Click **Set**.
4. In the Routing Table, click **Refresh** to display the new routing configuration.



## 2.9 X.32 Dialup Link

At least one of the packet switch links may be configured as a backup link. If a call cannot pass through the primary link, a backup link provides access to an X.25 network.

This example describes the addition of an X.32 dialup link to the X.25 to X.25 application described in Section 2.6. The configuration procedures include:

- Add an XID table entry
- Select an X.25 link (Link 3) as the backup link
- Set the backup link parameters
- Update the routing table

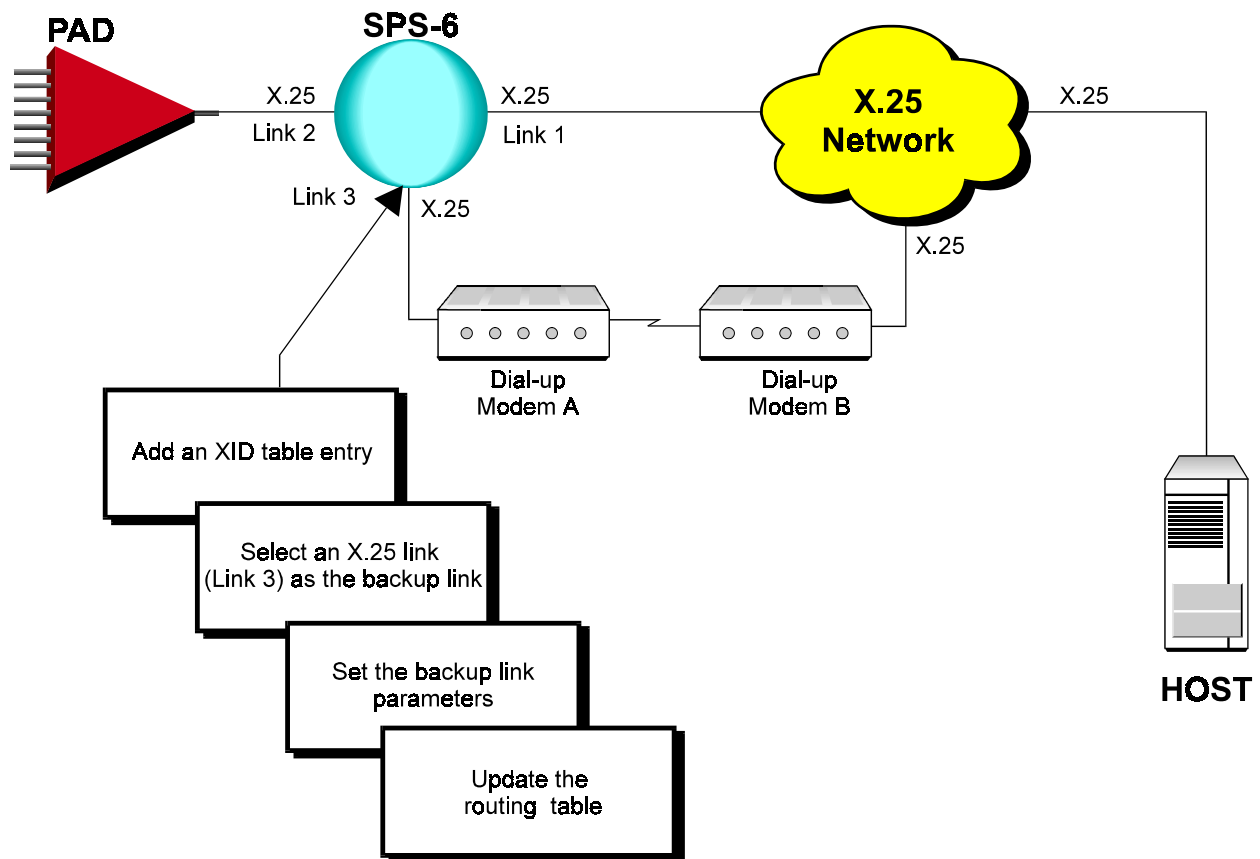

## Terminal Configuration Procedures



The following section describes the configuration procedures to add an X.32 dialup link to an X.25 to X.25 application

### ► Add an XID table entry

1. In the Configuration menu, choose **11** (X.32).

```
Configuration menu
-----
1) Channel
2) Profile
3) Link
4) System parameters
5) PVC
6) Call ID
7) NUI
8) Alias
9) Routing table
10) Funnel
11) X.32
12) Management
13) Multicast
14) IP configuration
15) ISDN configuration
16) SNA
CR) Exit

Select:
```

2. In the XID Table Configuration menu, choose **1** (Add XID Table).

```
XID table configuration
-----
1) Add XID table
2) Delete XID table
3) Update XID table
4) Display XID tables
CR) Exit

Select:
```

- In the XID Table x Configuration screen, add the XIDs (Exchange Identification string) of devices from which the packet switch may receive incoming calls and send outgoing calls.

```

XID table 2 configuration
-----
XID                               Dial-back phone
-----
1) *****                       | 14)
2)                               | 15)
3)                               | 16)
4)                               | 17)
5)                               | 18)
6)                               | 19)
7)                               | 20)
8)                               | 21)
9)                               | 22)
10)                              | 23)
11)                              | 24)
12)                              | 25)
13)                              | 26)

Outgoing XID                       Outgoing Phone number
-----
27)                               | 28)

enter: 1-28) Update parameters. S) save. CR) exit.

```

Choose **27** to add an outgoing XID string that defines the packet switching device when generating calls. This string is supplied by the network provider.

Choose **28** to add the phone number of Modem B.

Each selection opens the XID Table x Entry y screen. In this screen, type the required XID name or phone number and press **ENTER**.

```

XID table 2 entry 1
-----
Current value ... [ ***** ]

Possible values:
Up to 16 alphanumeric characters ('a'-'z', 'A'-'Z', '0'-'9')
- or the signs '*' or '_'.
'*' means Don't care.

Enter one of the above values or <RETURN> to exit:

```

- In the XID Table x Configuration screen, choose **S** to save the configuration.

➤ **Select an X.25 link (Link 3) as the backup link**

- See *X.25 Link Configuration, "Terminal Configuration Procedures, ➤ Select an X.25 link."* Perform all steps as instructed.

**Set the backup link parameters**

- See *X.25 to X.25, "Terminal Configuration Procedures, ➤ Set the Link 1 parameters."* Perform steps 1 to 4 of the procedure (for the backup link). Afterwards, perform the following steps:

1. In the Link x Configuration menu, choose **25** (XID Num). In the XID Num screen, type the number of the XID table entry that you configured in the above procedure, "**>** Add an XID table entry."

```

25) XID num
-----
Current value ... [0    ]

Possible values:
  0 - Disabled.
1..200 - A specific XID entry.

Enter one of the above values or <RETURN> to exit:

```

2. In the Link x Configuration menu, choose **23** (Line Option). In the Line Option screen, add the values of the parameters that match your specifications (for more information, see the *RAD Packet Switching Guide*).

```

23) LINE option
-----
Current value ... [1024 ]

Possible values:
0 - No options.
1..255 - TIME : Line will be disconnected after TIME if no
        session is open (0 : no disconnection).
256 - Dialed line .
512 - Return to leased line .
1024 - DTR is ON permanent .
2048 - DTR is OFF permanent.
XXXX - A valid combination of the values specified above.

Enter one of the above values or <RETURN> to exit:

```

For example, the value **773** (256 + 512 + 5) indicates that the link is a dialed line (256) that can be restored as a leased line (512). If no sessions pass through the link for 5 minutes (5), the system disconnects the link.

3. In the Link x Configuration menu, change other parameters according to your specifications or keep their default values. Choose **S** to save the configuration.

► **Update the routing table**

- In the *X.25 to X.25* application earlier in this chapter, the primary link was already configured as destination link 1. The routing for the backup link (destination link 2) goes from link 2 (PAD) to link 3 (Dialup modem link).

1. Press ENTER several times so that the Configuration menu reappears. In the Configuration menu, choose **9** (Routing Table).

```

Configuration menu
-----
1) Channel
2) Profile
3) Link
4) System parameters
5) PVC
6) Call ID
7) NUI
8) Alias
9) Routing table
10) Funnel
11) X.32
12) Management
13) Multicast
14) IP configuration
15) ISDN configuration
16) SNA
CR) Exit

Select:

```

2. In the Routing Table Entry Configuration menu, choose **3** (Update Routing Table Entry).

```

Routing Table entry configuration
-----
1) Add Routing Table entry
2) Delete Routing Table entry
3) Update Routing Table entry
4) Display Routing Table entries
CR) Exit

Select:

```

3. In the Routing Table Entry x Configuration menu, choose **2** (Link).

```

Routing table entry 1 configuration
-----
1) Link ..... [1      ] ----> 6) Priority ..... [1      ]
2) Link ..... [0      ] ----> 7) Priority ..... [1      ]
3) Link ..... [0      ] ----> 8) Priority ..... [1      ]
4) Address ..... [      ]
5) Stop search ... [1    ]
S) Save
CR) Exit

Select:

```

- In the Destination Link screen, type the X.25 link number of the dialup link.

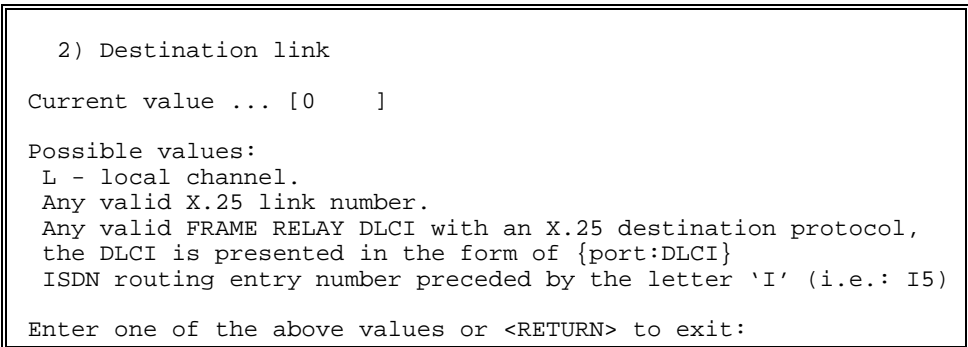

```
2) Destination link
Current value ... [0  ]
Possible values:
L - local channel.
Any valid X.25 link number.
Any valid FRAME RELAY DLCI with an X.25 destination protocol,
the DLCI is presented in the form of {port:DLCI}
ISDN routing entry number preceded by the letter 'I' (i.e.: I5)
Enter one of the above values or <RETURN> to exit:
```

- In the Routing Table Entry x Configuration menu, choose **6** (Priority). Type the number of times that the system will attempt to dial through the primary link (destination link 1) before dialing through the backup link.  
  
For example, **15** indicates that the system will attempt to dial through the primary link 15 times before dialing through the backup link (destination link 2).
- In the Routing Table Entry x Configuration menu, choose **S** to save the configuration.

## 2.10 NUI Asynchronous to Synchronous

An X.25 NUI (Network User Identification) application relies on passwords to restrict access to your network.

This section describes configuration procedures for an NUI Asynchronous to Synchronous application. This application requires configuration of a packet switch and a PAD. These procedures include:

- Add an NUI Group ID table entry
- Select the PAD's X.25 link that connects to the packet switch
- Set the PAD's X.25 link parameters
- Configure the PAD's Asynchronous channel that connects to a terminal.

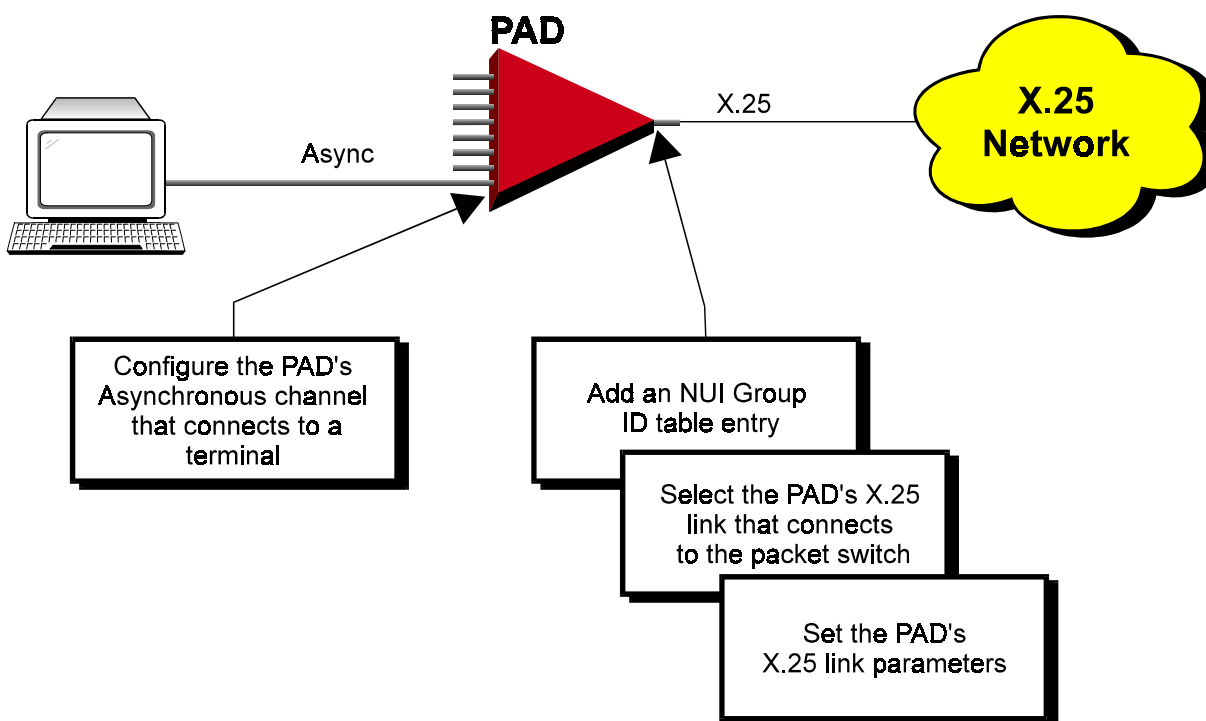

### Terminal Configuration Procedures



This section provides the configuration procedures for an NUI Asynchronous to Synchronous application.

#### ➤ Add an NUI Group ID table entry

1. Connect the setup terminal to the packet switch and load the Packet Switch command facility.

2. In the Configuration menu, choose 7 (NUI).

```
Configuration menu
-----
1) Channel
2) Profile
3) Link
4) System parameters
5) PVC
6) Call ID
7) NUI
8) Alias
9) Routing table
10) Funnel
11) X.32
12) Management
13) Multicast
14) IP configuration
15) ISDN configuration
16) SNA
CR) Exit

Select:
```

3. In the NUI Data Base Configuration menu, choose 1 (NUI Group ID Table).

```
NUI data base configuration
-----
1) NUI Group ID table
2) NUI out table
3) Address out table
CR) Exit

Select:
```

4. In the NUI Group ID Table Configuration menu, choose 1 (Add Group ID Table Entry).

```
NUI: Group ID table configuration
-----
1) Add Group ID table entry
2) Delete Group ID table entry
3) Update Group ID table entry
4) Display Group ID table entries
CR) Exit

Select:
```



5. In the NUI Group ID Table Configuration Entry *x* menu, define a group ID number and NUI In (in PAD applications, the Address In parameter is not applicable). Choose **S** to save the configuration.

```

NUI group ID table configuration: Entry 1
-----
1) Group ID ..... [0  ]
2) NUI in ..... [  ]
3) NUI out index ..... [0  ]
4) Address in ..... [  ]
5) Address out index ..... [0  ]
S) Save
CR) Exit

Select:

```

6. Press ENTER several times so that the NUI Data Base Configuration menu reappears. Choose **2** (NUI Out Table).

7. In the NUI Out Table Configuration Entry *x* screen, choose **1** (NUI Out).

```

NUI out table configuration: Entry 1
-----
1) NUI out ..... [  ]
S) Save
CR) Exit

Select:

```

8. Type the NUI Out value and press ENTER. In the NUI Out Table Configuration Entry *x* screen, choose **S** to save the configuration.

9. Press ENTER several times so that the NUI Data Base Configuration menu reappears. Choose **3** (Address Out Table).

10. In the NUI Address Out Table Configuration menu, choose **1** (Add Address Out Table Entry).

```

NUI: Address Out table configuration
-----
1) Add Address Out table entry
2) Delete Address Out table entry
3) Update Address Out table entry
4) Display Address Out table entries
CR) Exit

Select:

```

11. In the Address Out Table Configuration Entry *x* screen, choose **1** (Address Out).

```

Address out table configuration: Entry 1
-----
1) Address out ..... [  ]
S) Save
CR) Exit

Select:

```

12. Type the calling address of the PAD and press ENTER. In the Address Out Table Configuration Entry x screen, choose **S** to save the configuration.
13. Press ENTER several times so that the NUI Group ID Table Configuration Entry x menu reappears (see *figure in step 5*). Add the NUI Out Index and Address Out Index (Table Configuration entry numbers - see *figures in steps 7 and 11, respectively*). Choose **S** to save the configuration.

➤ **Select the PAD's X.25 link that connects to the packet switch**

1. Connect the setup terminal to the PAD that is connected to the packet switch and load the command facility.
2. See *X.25 Link Configuration, "Terminal Configuration Procedures, ➤ Select an X.25 link."* Perform all steps as instructed.

➤ **Set the PAD's X.25 link parameters**

**Note** Verify that the selected X.25 link is DTE.

1. In the Link x Configuration menu, choose **2** (DCE/DTE).

```

X.25 Link 1      configuration
-----
1) Address ..... [0  ] 17) LGN ..... [0  ]
2) DCE (1) / DTE (0)..... [1  ] 18) Lowest LCN (LIC) ..... [1  ]
3) Extended mode ..... [0  ] 19) Amount of Incoming LCNs .. [5  ]
4) T1 ..... [5  ] 20) Amount of Two Way LCNs ... [5  ]
5) T3 ..... [20 ] 21) Amount of Outgoing LCNs .. [5  ]
6) N2 ..... [10 ] 22) Internal Clock ..... [0  ]
7) k ..... [7  ] 23) LINE option ..... [1024 ]
8) w ..... [2  ] 24) Segment Size..... [128 ]
9) T10 ..... [18 ] 25) Xid num ..... [0  ]
10) T11 ..... [20 ] 26) NUI Group ID ..... [0  ]
11) T12 ..... [18 ] 27) Physical interface option. [0  ]
12) T13 ..... [18 ] 28) X.25 Acknowledge Counter . [1  ]
13) Packet size ..... [128 ] 29) X.25 Acknowledge Timer ... [0  ]
14) In call options ..... [1  ] 30) LAPB Acknowledge Counter . [1  ]
15) Out call options ..... [1  ] 31) LAPB Acknowledge Timer ... [0  ]
16) Subaddress length ..... [2  ] 32) CUG subscription ..... [5  ]
S) Save
CR) Exit

Select:

```

2. In the DCE/DTE screen, choose **0** (X.25 DTE).

```

2) DCE/DTE
-----
Current value ... [1  ]

Possible values:
0 - The link appears as a X25 DTE.
1 - The link appears as a X25 DCE.
2 - The link is X25->DCE and LAPB->DTE.
3 - The link is X25->DTE and LAPB->DCE.

Enter one of the above values or <RETURN> to exit:

```

3. In the Link x Configuration menu, change other parameters according to your specifications or keep their default values. Choose **S** to save the configuration.

➤ **Configure the PAD's Asynchronous channel that connects to a terminal**

1. See *Asynchronous Channel Configuration, "Terminal Configuration Procedures."* Perform all procedures as instructed. Afterwards, continue as follows:
2. In the Channel x Configuration menu, choose **12** (NUI Group ID).

```

Channel 1 configuration
-----
1) Profile number ..... [1   ]
2) Outgoing call profile number ... [0   ]
3) Incoming call profile number ... [0   ]
4) Remote profile number ..... [0   ]
5) Autocall ID ..... [0   ]
6) Alternate autocall ID ..... [0   ]
7) Autocall retries ..... [10  ]
8) Autocall retry interval ..... [5   ]
9) Call alias ..... [0   ]
10) Sub address1 ..... [00  ]
11) Sub address2 ..... [00  ]
12) NUI Group ID ..... [0   ]
13) Clear timer ..... [0   ]
14) Options ..... [0   ]
S) Save
CR) Exit

Select:

```

3. In the NUI Group ID screen, type the Group ID number as you defined it in the procedure, "➤ *Add an NUI Group ID table entry,*" step 5, earlier in this section.

```

12) NUI Group ID
-----
Current value ... [0   ]

Possible values:
0 - Disabled.
1..200 - A specific NUI Group ID.

Enter one of the above values or <RETURN> to exit:

```

4. In the Channel x Configuration menu, change other channel parameters according to your network specifications or keep their default values. Choose **S** to save the configuration.

**Note**

*One, more than one, or all of a packet switching device's channels can be in a single Group ID Table entry.*

## 2.11 NUI Synchronous to Synchronous

An X.25 NUI (Network User Identification) application relies on passwords to restrict access to your network.

This section describes configuration procedures for an NUI Synchronous to Synchronous application. These procedures include:

- Add an NUI Group ID table entry
- Select the packet switch's X.25 link that connects to the PAD
- Set the packet switch's X.25 link parameters
- Select the PAD's X.25 link that connects to the packet switch
- Set the PAD's X.25 link parameters
- Configure the PAD's Asynchronous channel that connects to a terminal.

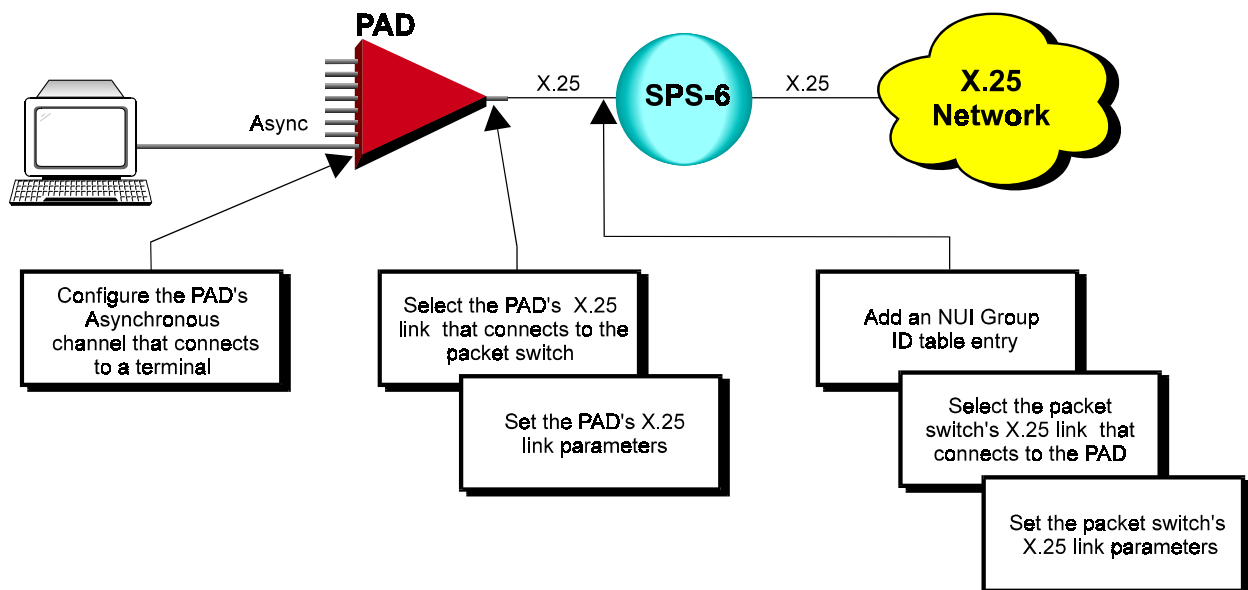

## Terminal Configuration Procedures



This section provides configuration procedures for a NUI Synchronous to Synchronous application.

### ► Add an NUI Group ID table entry

1. Connect the setup terminal to the packet switch and load the Packet Switch command facility.
2. In the Configuration menu, choose 7 (NUI).

```

Configuration menu
-----
1) Channel
2) Profile
3) Link
4) System parameters
5) PVC
6) Call ID
7) NUI
8) Alias
9) Routing table
10) Funnel
11) X.32
12) Management
13) Multicast
14) IP configuration
15) ISDN configuration
16) SNA
CR) Exit

Select:

```

3. In the NUI Data Base Configuration menu, choose 1 (NUI Group ID Table).

```

NUI data base configuration
-----
1) NUI Group ID table
2) NUI out table
3) Address out table
CR) Exit

Select:

```

4. In the NUI Group ID Table Configuration menu, choose 1 (Add Group ID Table Entry).

```

NUI: Group ID table configuration
-----
1) Add Group ID table entry
2) Delete Group ID table entry
3) Update Group ID table entry
4) Display Group ID table entries
CR) Exit

Select:

```

5. In the NUI Group ID Table Configuration Entry *x* menu, define a group ID number, NUI In, and Address In. Choose **S** to save the configuration.

```

NUI group ID table configuration: Entry 1
-----
1) Group ID ..... [0  ]
2) NUI in ..... [  ]
3) NUI out index ..... [0  ]
4) Address in ..... [  ]
5) Address out index ..... [0  ]
S) Save
CR) Exit

Select:

```

6. Press ENTER several times so that the NUI Data Base Configuration menu reappears. Choose **2** (NUI Out Table).

7. In the NUI Out Table Configuration Entry *x* screen, choose **1** (NUI Out).

```

NUI out table configuration: Entry 1
-----
1) NUI out ..... [  ]
S) Save
CR) Exit

Select:

```

8. Type the NUI Out value and press ENTER. In the NUI Out Table Configuration Entry *x* screen, choose **S** to save the configuration.

9. Press ENTER several times so that the NUI Data Base Configuration menu reappears. Choose **3** (Address Out Table).

10. In the NUI Address Out Table Configuration menu, choose **1** (Add Address Out Table Entry).

```

NUI: Address Out table configuration
-----
1) Add Address Out table entry
2) Delete Address Out table entry
3) Update Address Out table entry
4) Display Address Out table entries
CR) Exit

Select:

```

11. In the Address Out Table Configuration Entry *x* screen, choose **1** (Address Out).

```

Address out table configuration: Entry 1
-----
1) Address out ..... [  ]
S) Save
CR) Exit

Select:

```

12. Type the calling address of the PAD and press ENTER. In the Address Out Table Configuration Entry x screen, choose **S** to save the configuration.
13. Press ENTER several times so that the NUI Group ID Table Configuration Entry x menu reappears (see *figure in step 5*). Add the NUI Out Index and Address Out Index (Table Configuration entry numbers - see *figures in steps 7 and 11, respectively*). Choose **S** to save the configuration.

► **Select the packet switch's X.25 link that connects to the PAD**

- See *X.25 Link Configuration, "Terminal Configuration Procedures, ► Select an X.25 link."*

► **Set the packet switch's X.25 link parameters**

**Note**

Verify that the selected X.25 link is DCE.

1. In the Link x Configuration menu, choose **2** (DCE/DTE). In the DCE/DTE screen, choose **1** (X.25 DCE).

```

2) DCE/DTE
-----
Current value ... [1  ]
Possible values:
0 - The link appears as a X25 DTE.
1 - The link appears as a X25 DCE.
2 - The link is X25->DCE and LAPB->DTE.
3 - The link is X25->DTE and LAPB->DCE.

Enter one of the above values or <RETURN> to exit:

```

2. In the Link x Configuration menu, choose **22** (Internal Clock) to set the baud rate of the link. In the Internal Clock menu, choose the option number according to your specifications.

```

22) Internal Clock
-----
Current value ... [0  ]
Possible values:

0 - External clock

Internal Clock
-----
1 - 2.4 Kbps      10 - 128 Kbps
2 - 4.8 Kbps      11 - 256 Kbps
3 - 9.6 Kbps      12 - 384 Kbps
4 - 14.4 Kbps     13 - 512 Kbps
5 - 19.2 Kbps     14 - 768 Kbps
6 - 38.4 Kbps     15 - 1008 Kbps
7 - 48 Kbps       16 - 1466 Kbps
8 - 56 Kbps       17 - 2016 Kbps
9 - 64 Kbps

Enter one of the above values or <RETURN> to exit:

```

3. In the Link x Configuration menu, choose **26** (NUI Group ID). In the NUI Group ID screen, type the Group ID number as you defined it in the procedure, “► Add an NUI Group ID table entry,” step 5, earlier in this section.

```

26) NUI Group ID
-----
Current value ... [0    ]

Possible values:
0 - Disabled.
1..200 - A specific NUI Group ID.

Enter one of the above values or <RETURN> to exit:

```

► **Select the PAD's X.25 link that connects to the packet switch**

1. Connect the setup terminal to the PAD that is connected to the packet switch and load the command facility.
2. See *X.25 Link Configuration, "Terminal Configuration Procedures, ► Select an X.25 link."* Perform all steps as instructed.

► **Set the PAD's X.25 link parameters**

**Note**

Verify that the selected X.25 link is DTE.

1. In the Link x Configuration menu, choose **2** (DCE/DTE).

```

X.25 Link 1      configuration
-----
1) Address ..... [0    ] 17) LGN ..... [0    ]
2) DCE (1) / DTE (0)..... [1    ] 18) Lowest LCN (LIC) ..... [1    ]
3) Extended mode ..... [0    ] 19) Amount of Incoming LCNs .. [5    ]
4) T1 ..... [5    ] 20) Amount of Two Way LCNs ... [5    ]
5) T3 ..... [20   ] 21) Amount of Outgoing LCNs .. [5    ]
6) N2 ..... [10   ] 22) Internal Clock ..... [0    ]
7) k ..... [7    ] 23) LINE option ..... [1024 ]
8) w ..... [2    ] 24) Segment Size..... [128  ]
9) T10 ..... [18   ] 25) Xid num ..... [0    ]
10) T11 ..... [20   ] 26) NUI Group ID ..... [0    ]
11) T12 ..... [18   ] 27) Physical interface option. [0    ]
12) T13 ..... [18   ] 28) X.25 Acknowledge Counter . [1    ]
13) Packet size ..... [128 ] 29) X.25 Acknowledge Timer ... [0    ]
14) In call options ..... [1    ] 30) LAPB Acknowledge Counter . [1    ]
15) Out call options ..... [1    ] 31) LAPB Acknowledge Timer ... [0    ]
16) Subaddress length ..... [2    ] 32) CUG subscription ..... [5    ]
S) Save
CR) Exit

Select:

```

2. In the DCE/DTE screen, choose **0** (X.25 DTE).

```

2) DCE/DTE
-----
Current value ... [1    ]

Possible values:
0 - The link appears as a X25 DTE.
1 - The link appears as a X25 DCE.
2 - The link is X25->DCE and LAPB->DTE.
3 - The link is X25->DTE and LAPB->DCE.

Enter one of the above values or <RETURN> to exit:

```



3. In the Link *x* Configuration menu, change other parameters according to your specifications or keep their default values. Choose **S** to save the configuration.

---

**Note**

*One, more than one, or all of a packet switching device's links can be in a single Group ID Table entry.*

---

- **Configure the PAD's Asynchronous channel that connects to a terminal**
  - See *Asynchronous Channel Configuration, "Terminal Configuration Procedures."* Perform all steps as instructed.

---

## 2.12 ISDN Backup Link (X.25 Network)

In this application, at least one of the packet switch links may be configured as a backup link. If a call cannot pass through the primary link, a backup link can provide connection to another packet switch over an ISDN network. When the primary link returns to normal operation, the ISDN link disconnects and communication resumes through the primary link.

This section describes the configuration procedures for an X.25 backup link between two packet switches (in this example, SPS-6 and APS-8) through an ISDN network. The configuration procedures for *both* packet switches include:

- Select an X.25 link (Link 3) that connects to an X.25 network
- Set the Link 3 parameters
- Add a routing table entry
- Select an X.25 link (Link 1) as the backup link
- Set the ISDN routing parameters
- Update the routing table
- Set up an ISDN Accept List (optional for both packet switches).

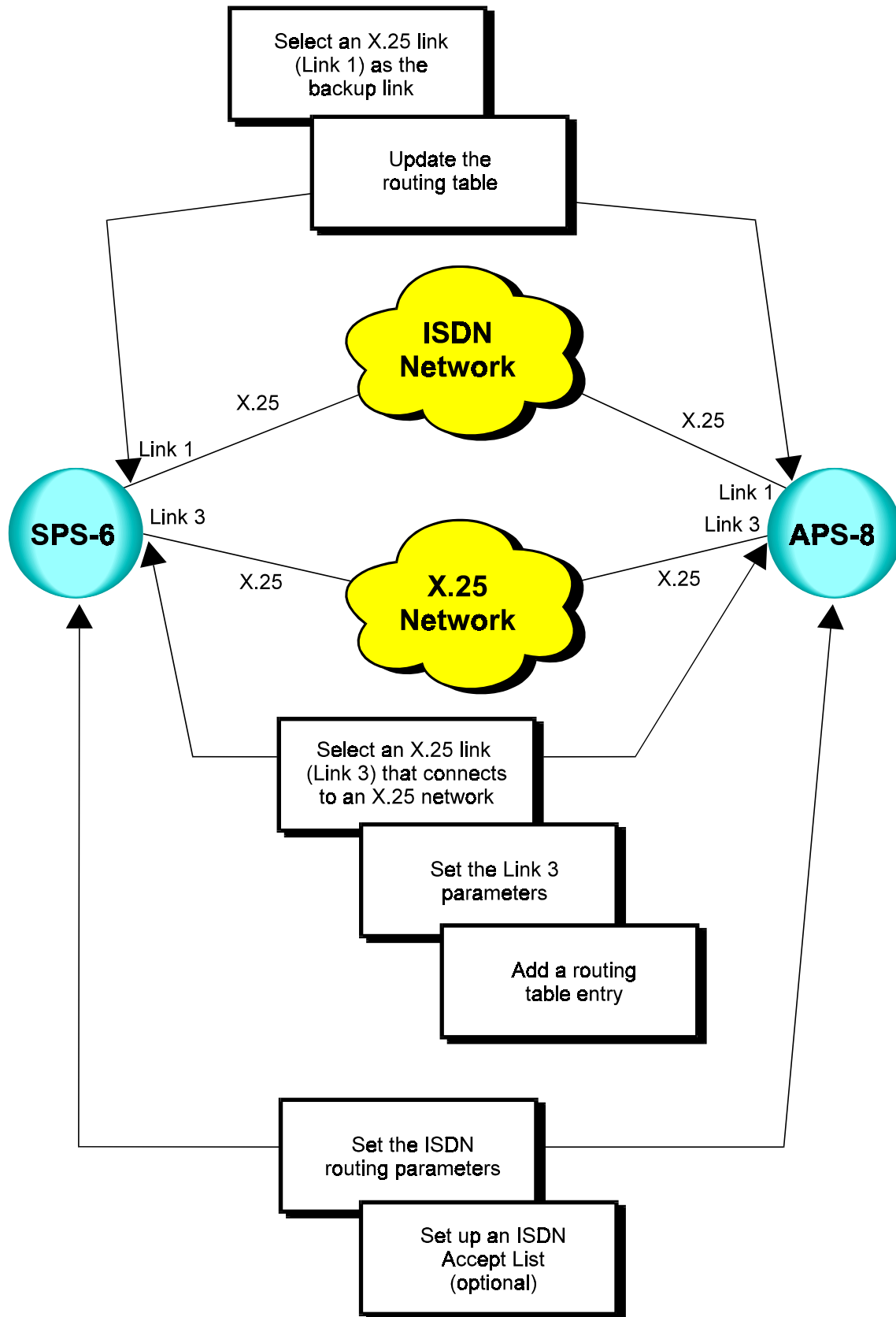

## Terminal Configuration Procedures



This following section describes the configuration procedures for an X.25 backup link between two packet switches (in this example, SPS-6 and APS-8) through an ISDN network.

### Notes

1. This application requires prior installation of a MOBI interface card in the following synchronous links, depending on the packet switch models used in your application:

For SPS-12 - link nos. 1 & 2 and/or 7 & 8.

For APD-8 - link no. 1.

For SPS-3S and APS devices - link no. 1 and/or 2.

For FPS-8 - any link

2. Verify that Link 3 is set to DCE in the X.25 layer of the SPS-6. In addition, verify that Link 3 is set to DTE in the X.25 layer of the APS-8.

### ► Select an X.25 link (Link 3) that connects to an X.25 network (SPS-6)

- See *X.25 Link Configuration*, "Terminal Configuration Procedures, ► Select an X.25 link." Perform all steps as instructed.

### ► Set the Link 3 parameters (SPS-6)

1. In the Link x Configuration menu, choose **8** (W). In the W screen, type the same value as the X.25 network's W value.

```

      8) w
      -----
      Packet window size.
      Current value ... [2    ]

      Possible values:
      1 - 7   : for operation in basic mode.
      1 - 127 : for operation in extended mode.
  
```

► Enter one of the above values or <RETURN> to exit:

2. In the Link x Configuration menu, choose **13** (Packet Size). In the Packet Size screen, choose the same value as the X.25 network's Packet Size value.

```

      13) Packet size
      -----
      Current value ... [128  ]

      Possible values:
      0 - 4096
      frequent values are:
      128,256,512,1024,2048,4096
  
```

► Enter one of the above values or <RETURN> to exit:

3. In the Link x Configuration menu, choose **S** to save the configuration.

➤ **Add a routing table entry (SPS-6)**

In this application, the routing goes from link 3 of the SPS-6 to link 3 of the APS-8.

- See *X.25 Link Configuration, "Terminal Configuration Procedures, ➤ Add a routing table entry."* Perform steps 1 to 3 of the procedure. Afterwards, perform the following steps:

1. In the Destination Link screen, type **3** as the valid X.25 link number.

```

1) Destination link
Current value ... [1  ]
Possible values:
L - local channel.
Any valid X.25 link number.
Any valid FRAME RELAY DLCI with an X.25 destination protocol,
the DLCI is presented in the form of {port:DLCI}
ISDN routing entry number preceded by the letter 'I' (i.e.: I5)
Enter one of the above values or <RETURN> to exit:

```

2. In the Routing Table Entry x Configuration menu, choose **4** (Address). In the Address screen, type the X.25 address of the APS-8.

```

4) Address
-----
Current value ... [  ]
Possible values:
Up to 15 decimal digits or X (don't care) digits.
Enter one of the above values or <RETURN> to exit:

```

3. In the Routing Table Entry x Configuration menu, choose **S** to save the configuration.

➤ **Select an X.25 link (Link 1) as the backup link (SPS-6)**

- See *X.25 Link Configuration, "Terminal Configuration Procedures, ➤ Select an X.25 link."* Perform all steps as instructed.

**Set the ISDN routing parameters (SPS-6)**

1. Press **ENTER** several times so that the Configuration menu reappears. In the Configuration menu, choose **15** (ISDN Configuration).

```

Configuration menu
-----
1) Channel
2) Profile
3) Link
4) System parameters
5) PVC
6) Call ID
7) NUI
8) Alias
9) Routing table
10) Funnel
11) X.32
12) Management
13) Multicast

```

```
▶ 14) IP configuration
   15) ISDN configuration
   16) SNA
   CR) Exit

   Select:
```

2. In the ISDN Configuration menu, choose **2** (ISDN Routing Table).

```
▶ ISDN configuration
   -----

   1) Global Configuration.
   2) ISDN Routing Table.
   3) ISDN Accept List Table.
   4) Update ISDN Link Parameters.
   5) Display ISDN Link Parameters.
   CR) Exit.

   Select:
```

3. In the ISDN Routing Configuration menu, choose **1** (Add ISDN Routing Entry).

```
▶ ISDN Routing Configuration
   -----

   1) Add ISDN Routing Entry
   2) Delete ISDN Routing Entry
   3) Update ISDN Routing Entry
   4) Display ISDN Routing Entry
   CR) Exit

   Select:
```

Type **1** as the ISDN Routing number and press ENTER.

- In the ISDN Routing Entry x Configuration menu, choose **1** (Outgoing Address).

```
ISDN routing entry 1 configuration
-----
1) Outgoing Address ..... [   ]
2) Outgoing Subaddress ..... [   ]
3) Alternate Address 1 ..... [   ]
4) Alternate Subaddress 1 ..... [   ]
5) Alternate Address 2 ..... [   ]
6) Alternate Subaddress 2 ..... [   ]
7) ISDN Speed..... [1   ]
8) Options ..... [0   ]
S) Save.
CR) Exit.

Select:
```

- In the Outgoing Address screen, type the ISDN phone number of the APS-8 (for example, **6451234**).

```
1) Outgoing address
-----

Current value ... [   ]

Possible values:
Up to 17 decimal digits.

Enter one of the above values or <RETURN> to exit:
```

- In the ISDN Routing Entry x Configuration menu, choose **S** to save the configuration.

➤ **Update the routing table (SPS-6)**

- In the previous procedure, the primary X.25 link of the SPS-6 was configured in the routing table as destination link 3. The routing for the ISDN link of the SPS-6 (destination link 2) goes to the link specified in the ISDN routing table (see the procedure, “➤ *Set the ISDN routing parameters (SPS-6)*,” earlier in this section).

1. Press ENTER several times so that the Configuration menu reappears. In the Configuration menu, choose **9** (Routing Table).

```

Configuration menu
-----
1) Channel
2) Profile
3) Link
4) System parameters
5) PVC
6) Call ID
7) NUI
8) Alias
9) Routing table
10) Funnel
11) X.32
12) Management
13) Multicast
14) IP configuration
15) ISDN configuration
16) SNA
CR) Exit

Select:

```

2. In the Routing Table Entry Configuration menu, choose **3** (Update Routing Table Entry).

```

Routing Table entry configuration
-----
1) Add Routing Table entry
2) Delete Routing Table entry
3) Update Routing Table entry
4) Display Routing Table entries
CR) Exit

Select:

```

3. In the Routing Table Entry x Configuration menu, choose **2** (Link).

```

Routing table entry 1 configuration
-----
1) Link ..... [1      ] ----> 6) Priority ..... [1  ]
2) Link ..... [0      ] ----> 7) Priority ..... [1  ]
3) Link ..... [0      ] ----> 8) Priority ..... [1  ]
4) Address ..... [      ]
5) Stop search ... [1  ]
S) Save
CR) Exit

Select:

```



4. In the Destination Link screen, type **11**. "1" indicates ISDN and "1" is the ISDN routing number (see the procedure, "► *Set the ISDN routing parameters (SPS-6)*", *step 3*, earlier in this section).

```

2) Destination link

Current value ... [0    ]

Possible values:
L - local channel.
Any valid X.25 link number.
Any valid FRAME RELAY DLCI with an X.25 destination protocol,
the DLCI is presented in the form of {port:DLCI}
ISDN routing entry number preceded by the letter 'I' (i.e.: I5)

Enter one of the above values or <RETURN> to exit:

```

5. In the Routing Table Entry x Configuration menu, choose **S** to save the configuration.

► **Select an X.25 link (Link 3) that connects to an X.25 network (APS-8)**

- See *X.25 Link Configuration, "Terminal Configuration Procedures, ► Select an X.25 link."* Perform all steps as instructed.

► **Set the Link 3 parameters (APS-8)**

1. In the Link x Configuration menu, choose **2** (DCE/DTE).

```

X.25 Link 1      configuration
-----
1) Address ..... [0    ] 17) LGN ..... [0    ]
2) DCE (1) / DTE (0)..... [1    ] 18) Lowest LCN (LIC) ..... [1    ]
3) Extended mode ..... [0    ] 19) Amount of Incoming LCNs .. [5    ]
4) T1 ..... [5    ] 20) Amount of Two Way LCNs ... [5    ]
5) T3 ..... [20   ] 21) Amount of Outgoing LCNs .. [5    ]
6) N2 ..... [10   ] 22) Internal Clock ..... [0    ]
7) k ..... [7    ] 23) LINE option ..... [1024 ]
8) w ..... [2    ] 24) Segment Size..... [128  ]
9) T10 ..... [18   ] 25) Xid num ..... [0    ]
10) T11 ..... [20   ] 26) NUI Group ID ..... [0    ]
11) T12 ..... [18   ] 27) Physical interface option. [0    ]
12) T13 ..... [18   ] 28) X.25 Acknowledge Counter . [1    ]
13) Packet size ..... [128 ] 29) X.25 Acknowledge Timer ... [0    ]
14) In call options ..... [1    ] 30) LAPB Acknowledge Counter . [1    ]
15) Out call options ..... [1    ] 31) LAPB Acknowledge Timer ... [0    ]
16) Subaddress length ..... [2    ] 32) CUG subscription ..... [5    ]
S) Save
CR) Exit

Select:

```

2. In the DCE/DTE screen, choose **0** (X.25 DTE).

```

2) DCE/DTE
-----
Current value ... [1    ]

Possible values:
0 - The link appears as a X25 DTE.
1 - The link appears as a X25 DCE.
2 - The link is X25->DCE and LAPB->DTE.
3 - The link is X25->DTE and LAPB->DCE.

Enter one of the above values or <RETURN> to exit:

```

3. In the Link x Configuration menu, choose **8** (W). In the W screen, type the same value as the X.25 network's W value.
4. In the Link x Configuration menu, choose **13** (Packet Size). In the Packet Size screen, choose the same value as the X.25 network's Packet Size value.
5. In the Link x Configuration menu, choose **S** to save the configuration.

➤ **Add a routing table entry (APS-8)**

In this application, the routing goes from link 3 of the APS-8 to link 3 of the SPS-6.

- See the procedure, "➤ *Add a routing table entry (SPS-6)*," earlier in this section. Perform steps 1 to 4 of the procedure. Afterwards, perform the following steps:

1. In the Routing Table Entry x Configuration menu, choose **4** (Address). In the Address screen, type the X.25 address of the SPS-6.
2. In the Routing Table Entry x Configuration menu, choose **S** to save the configuration.

➤ **Select an X.25 link (Link 1) as the backup link (APS-8)**

- See *X.25 Link Configuration, "Terminal Configuration Procedures, ➤ Select an X.25 link."* Perform all steps as instructed.

➤ **Set the ISDN routing parameters (APS-8)**

- See the procedure, "➤ *Set the ISDN routing parameters (SPS-6)*," earlier in this section. Perform steps 1 to 4 as instructed. Afterwards, perform the following steps:

1. In the Outgoing Address screen, type the ISDN phone number of the SPS-6.
2. In the ISDN Routing Entry x Configuration menu, choose **S** to save the configuration.

➤ **Update the routing table (APS-8)**

In the previous procedure, the primary X.25 link of the APS-8 was configured in the routing table as destination link 3. The routing for the ISDN link of the APS-8 (destination link 2) goes to the link specified in the ISDN routing table (see the procedure, "➤ *Set the ISDN routing parameters (SPS-6)*," earlier in this section).

- See the procedure, "➤ *Update the routing table (SPS-6)*," earlier in this section. Perform all steps as instructed.

➤ **Set up an ISDN Accept List (optional for both packet switches)**

As an option, you can set up an ISDN Accept List for the packet switches in your network. In the Accept List, you can define a Calling Address from which the packet switch will accept calls. In addition, you can define a Dialback Address to confirm the source of the incoming call.

1. Press ENTER several times so that the Configuration menu reappears. In the Configuration menu, choose **15** (ISDN Configuration).
2. In the ISDN Configuration menu, choose **3** (ISDN Accept List Table).

```

ISDN configuration
-----

1) Global Configuration.
2) ISDN Routing Table.
3) ISDN Accept List Table.
4) Update ISDN Link Parameters.
5) Display ISDN Link Parameters.
CR) Exit.

Select:

```

3. In the ISDN Accept List Configuration menu, choose **1** (Add ISDN Accept List Entry).

```

ISDN Accept List Configuration
-----

1) Add ISDN Accept List Entry.
2) Delete ISDN Accept List Entry.
3) Update ISDN Accept List Entry.
4) Display ISDN Accept List Entry.
CR) Exit.

Select:

```

Type **200** as the ISDN Accept List index number (200 is the default).

4. In the ISDN Accept List Entry xxx Configuration menu, choose **1** (Primary Link Number).

```

ISDN accept list entry 1 configuration
-----

1) Primary Link Number ..... [A  ]
2) Secondary link number ..... [0  ]
3) Calling Address ..... [XXXXXXXXXXXXXXXXXXXX]
4) Calling Subaddress..... [XXXXXX]
5) Dialback Address ..... [  ]
6) Dialback Subaddress ..... [  ]
S) Save.
CR) Exit.

Select:

```

5. In the Primary Link Number screen, type the specific link number that you want to route the call. **A** indicates the first available link.

1) Primary link number  
-----  
Current value ... [A ]  
Possible values:  
<A> - Available. (First available ISDN link of the receiving MOBI).  
Or  
Any valid ISDN link number.

▶ Enter one of the above values or <RETURN> to exit:

6. In the ISDN Accept List Entry xxx Configuration menu, choose **3** (Calling Address).

7. In the Calling Address screen, type the ISDN phone number of the incoming caller (XXXXXXXXXXXXXXXXXX indicates any phone number).

3) Calling address  
-----  
Calling address of the incoming call.  
Current value ... [XXXXXXXXXXXXXXXXXX]  
Possible values:  
Up to 17 decimal digits.

▶ Enter one of the above values or <RETURN> to exit:

8. In the ISDN Accept List Entry xxx Configuration menu, choose **4** (Calling Subaddress).

9. In the Calling Subaddress screen, type the specific local link number of the incoming caller (XXXXXX indicates any link number).

4) Calling subaddress  
-----  
Calling subaddress of the incoming call.  
Current value ... [XXXXXX]  
Possible values:  
Up to 6 decimal digits.

▶ Enter one of the above values or <RETURN> to exit:

10. In the ISDN Accept List Entry xxx Configuration menu, choose **5** (Dialback Address).

11. In the Dialback Address screen, type the ISDN phone number for the packet switch to dial to confirm the source of the incoming call.

**Note**

*The Dialback Address must be identical to the Calling Address of the source of the incoming call.*

```
5) Dialback address
-----
Current value ... [      ]
Possible values:
Up to 17 decimal digits.
Enter <SPACE> to delete address and cancel Dialback option.

Enter one of the above values or <RETURN> to exit:
```

12. In the ISDN Accept List Entry xxx Configuration menu, choose **6** (Dialback Subaddress).

13. In the Dialback Subaddress screen, type the specific local link number of the incoming caller that the packet switch will dial to confirm the source of the incoming call.

```
6) Dialback subaddress
-----
Current value ... [      ]
Possible values:
Up to 6 decimal digits.
Enter <SPACE> to delete.

Enter one of the above values or <RETURN> to exit:
```

14. In the ISDN Accept List Entry xxx Configuration menu, choose **S** to save the configuration.

## 2.13 Frame Relay Network/Frame Relay User

In this application, data passing through a router is switched through Frame Relay links to a Frame Relay network.

This section describes configuration procedures for a Frame Relay Network/Frame Relay User application. Configuration settings are determined by the packet switching device's relationship in the application to other connected devices. These procedures include:

- Set two links to Frame Relay
- Configure Link 1 as the network side
- Configure Link 2 as the user side
- Add a DLCI for Link 1
- Add a DLCI for Link 2
- Configure the Link 1 DLCI
- Configure the Link 2 DLCI.

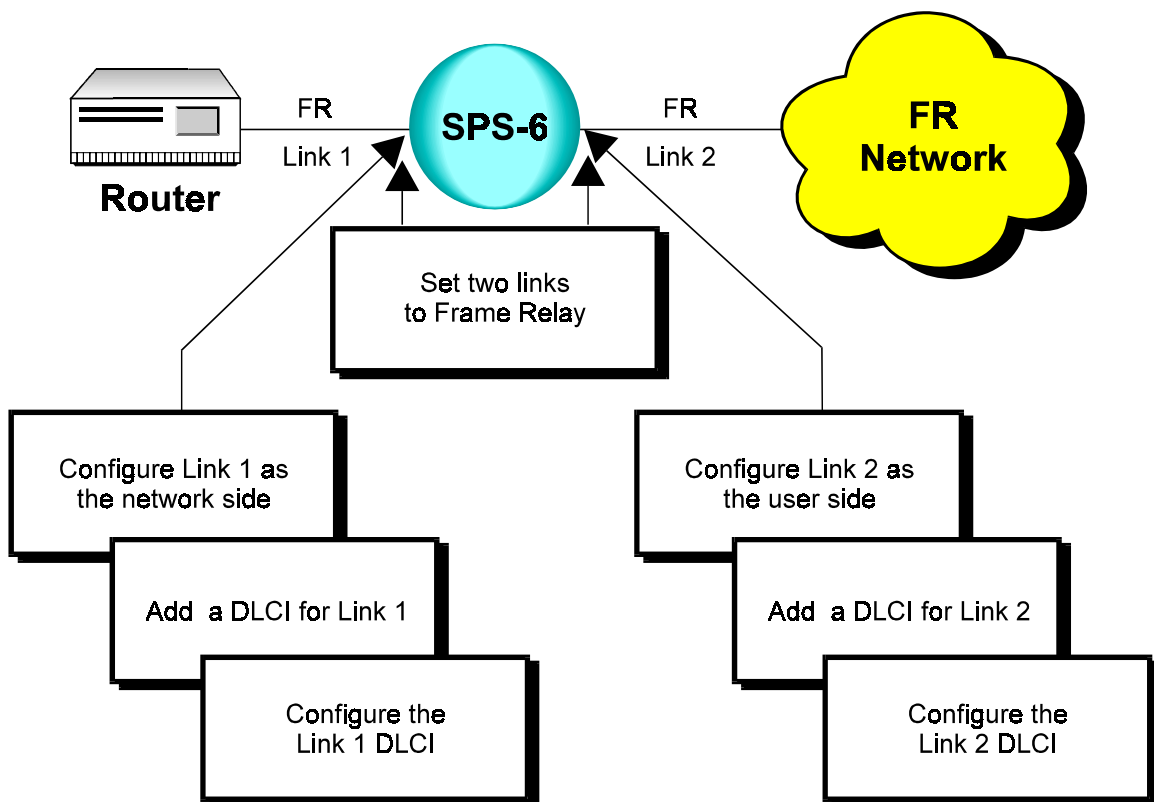

## Terminal Configuration Procedures



This section describes terminal configuration procedures for a Frame Relay Network/Frame Relay User application.

### ► Set two links to Frame Relay

In this application, link 1 connects to a router and Link 2 connects to a Frame Relay network.

- Select two links and set their link types to Frame Relay. See *Frame Relay Link Configuration*, “Terminal Configuration Procedures, ► Set a link to Frame Relay.” Perform all steps as instructed for each link.

### ► Configure Link 1 as the network side

- See *Frame Relay Link Configuration*, “Terminal Configuration Procedures, ► Set the Frame Relay port parameters.” Perform steps 1 to 5 of the procedure. Afterwards, perform the following steps:

1. In the Maintenance Protocol Mode screen, choose **1** (Network-side).

```

2) Maintenance protocol mode
-----
This field defines the mode of maintenance protocol running
over this port.
Current value ... [1    ]

Possible values:
0 - Perform user-side procedure on this port.
1 - Perform network-side procedure on this port.
2 - Perform NNI (Network to Network Interface) procedure
   on this port.

Enter one of the above values or <RETURN> to exit:

```

2. In the Frame Relay Port x Configuration menu, choose **13** (Internal Clock) to set the baud rate of the link.

```

FRAME RELAY port 1    configuration
-----
1) Maintenance protocol ..... [1    ]
2) Maintenance protocol mode ..... [1    ]
3) T391 (Link Integrity Verification Timer) .. [10   ]
4) T392 (Link Polling Verification Timer) .... [15   ]
5) N391 (Full Status Polling Cycle) ..... [6    ]
6) N392 (Error Threshold) ..... [3    ]
7) N393 (Monitored Events Count) ..... [4    ]
8) Rx pool red line (Frames)..... [4    ]
9) Rx pool OK (Frames)..... [6    ]
10) Tx pool red line (Frames)..... [40   ]
11) Tx pool OK (Frames)..... [30   ]
12) Tx ceiling (Frames)..... [50   ]
13) Internal Clock ..... [0    ]
14) HDLC options ..... [0    ]
15) Physical interface option ..... [0    ]
16) DLCI Header Mode ..... [0    ]

S) Save
CR) Exit

Select:

```

- In the Internal Clock menu, choose the option number according to your specifications.

```

13) Internal Clock
-----
Current value ... [0  ]

Possible values:

0 - External clock

Internal Clock
-----
1 - 2.4 Kbps      10 - 128 Kbps
2 - 4.8 Kbps      11 - 256 Kbps
3 - 9.6 Kbps      12 - 384 Kbps
4 - 14.4 Kbps     13 - 512 Kbps
5 - 19.2 Kbps     14 - 768 Kbps
6 - 38.4 Kbps     15 - 1008 Kbps
7 - 48 Kbps       16 - 1466 Kbps
8 - 56 Kbps       17 - 2016 Kbps
9 - 64 Kbps

Enter one of the above values or <RETURN> to exit:

```

- In the Frame Relay Port x Configuration menu, change other port parameters according to your network specifications or keep their default values. Choose **S** to save the configuration.

➤ **Configure Link 2 as the user side**

- See *Frame Relay Link Configuration, "Terminal Configuration Procedures, ➤ Set the Frame Relay port parameters."* Perform steps 1 to 5 of the procedure. Afterwards, perform the following steps:

- In the Maintenance Protocol Mode screen, choose **0** (User-side).

```

2) Maintenance protocol mode
-----
This field defines the mode of maintenance protocol running
over this port.
Current value ... [1  ]

Possible values:
0 - Perform user-side procedure on this port.
1 - Perform network-side procedure on this port.
2 - Perform NNI (Network to Network Interface) procedure
   on this port.

Enter one of the above values or <RETURN> to exit:

```

- In the Frame Relay Port x Configuration menu, change other port parameters according to your network specifications or keep their default values. Choose **S** to save the configuration.



➤ **Add a DLCI for Link 1**

1. Press **ENTER** several times so that the Link Configuration menu reappears. In the Link Configuration menu, choose **3** (Update Link Parameters).

```

Link configuration
-----
1) Set Link type.
2) Display Links protocols.
3) Update Link parameters.
4) Display Links parameters.
CR) Exit

Select:

```

2. Choose the number of the Frame Relay link connected to the router (Link 1).

```

Link | 1 | 2 | 3 | 4 | 5 | 6 |
-----|-----|-----|-----|-----|-----|
Prot | FR | FR | X.25 | X.25 | X.25 | X.25 |

Enter Link number to update:

```

3. In the Frame Relay Link x Configuration menu, choose **1** (Add DLCI).

```

FRAME RELAY Link 1 configuration
-----
1) Add DLCI.
2) Delete DLCI.
3) Update PORT parameters.
4) Update DLCI parameters.
CR) Exit

Select:

```

4. Type a number for the new DLCI (**16** to **991**).

➤ **Add a DLCI for Link 2**

- Repeat the above procedure, “➤ Add a DLCI for Link 1.” In step 2, choose the number of the Frame Relay link connected to the Frame Relay network (Link 2).

➤ **Configure the Link 1 DLCI**

1. Press **ENTER** several times so that the Link Configuration menu reappears. In the Link Configuration menu, choose **3** (Update Link Parameters).
2. Choose the number of the Frame Relay link connected to the router (Link 1).

3. In the Frame Relay Link x Configuration menu, choose **4** (Update DLCI Parameters).

```

FRAME RELAY Link 1      configuration
-----
1) Add DLCI.
2) Delete DLCI.
3) Update PORT parameters.
4) Update DLCI parameters.
CR) Exit

Select:

```

4. In the DLCI xxx Link x menu, choose **1** (Update DLCI Configuration).

```

DLCI 100   Link 1
-----
1) Update DLCI configuration.
2) Update X25 configuration.
CR) Exit

Select:

```

5. In the DLCI xxx Link x Configuration menu, choose **1** (Encapsulation Type).

```

DLCI 100   Link 3      configuration
-----
1) Encapsulation Type ..... [2   ]
2) Destination Id ..... [0:0 ]
3) Backup DLCI ..... [0:0 ]
4) Tx Tc (1/10 Sec) ..... [10  ]
5) Tx Bc (Bytes per Tx Tc) ..... [65000]
6) Tx Be (Bytes per Tx Tc) ..... [65000]
7) Rx Tc (1/10 Sec) ..... [10  ]
8) Rx Bc (Bytes per Rx Tc) ..... [65000]
9) Rx Be (Bytes per Rx Tc) ..... [65000]
10) Funnel id ..... [0   ]
11) Tx Priority ..... [0   ]
12) ISDN Destination ..... [0   ]
S) Save
CR) Exit

Select:

```

6. In the Encapsulation Type screen, choose **2** (No Protocol Encapsulation).

```

1) Encapsulation Type
-----
Current value ... [2   ]

Possible values:
1 - X25 encapsulation.
2 - No protocol encapsulation.
3 - Transparent HDLC encapsulation.
4 - Asynchronous encapsulation.
5 - Multi Point Encapsulation.
6 - RFC1490 encapsulation.
7 - Multicast

Enter one of the above values or <RETURN> to exit:

```

7. In the DLCI xxx Link x Configuration menu, choose **2** (Destination ID). In the Destination ID screen, type the number of the link connecting to the Frame Relay network (Link 2), a colon and the DLCI number of the Frame Relay network (for example, **2:18** indicates Link 2 and DLCI 18).

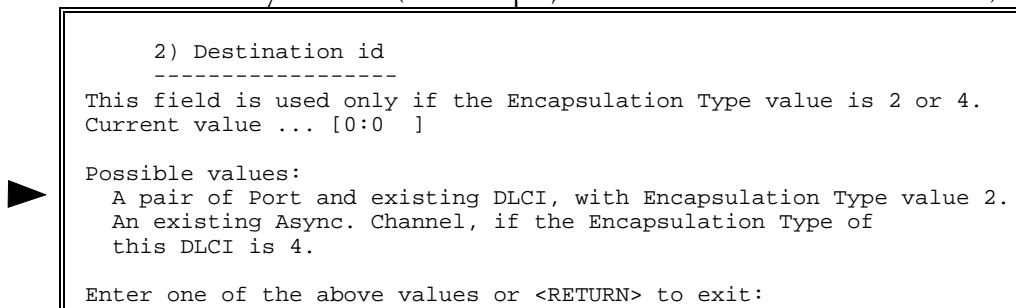

8. Change other DLCI parameters according to your network specifications or keep their default values. Choose **S** to save the configuration.

#### ➤ Configure the Link 2 DLCI

- Repeat steps 1 to 6 of the above procedure, “➤ *Configure the Link 1 DLCI.*” In step 2, choose the number of the Frame Relay link connected to the Frame Relay network (Link 2).

1. In the DLCI xxx Link x Configuration menu, choose **2** (Destination ID). In the Destination ID screen, type the number of the link connecting to the router (Link 1), a colon and the DLCI number of the router (for example, **1:17** indicates Link 1 and DLCI 17).
2. Change other DLCI parameters according to your network specifications or keep their default values. Choose **S** to save the configuration.

This section describes RADview configuration procedures for a Frame Relay Network/Frame Relay User application.

#### ➤ Set two links to Frame Relay

### RADview Configuration Procedures



In this application, link 1 connects to a router and Link 2 connects to a Frame Relay network.

- See *Frame Relay Link Configuration, “RADview Configuration Procedures, ➤ Set a link to Frame Relay.”* Perform steps 1 to 3 for one of the links. Afterwards, perform the following steps:
  3. Click **Save**. Click **OK** to confirm.
  4. For the second link, repeat steps 1 to 4 of this procedure.
  5. Perform reset to implement the protocol type change.

➤ **Configure Link 1 as the network side**

1. In the PS View window, double-click the Frame Relay link that connects to the router (Link 1). The Link 1 FR window appears.

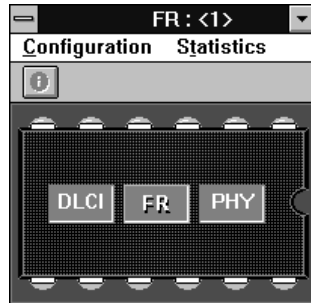

2. In the FR window, click **FR**. On the FR **Configuration** menu, point to **Parameters** and click **Full Config**.

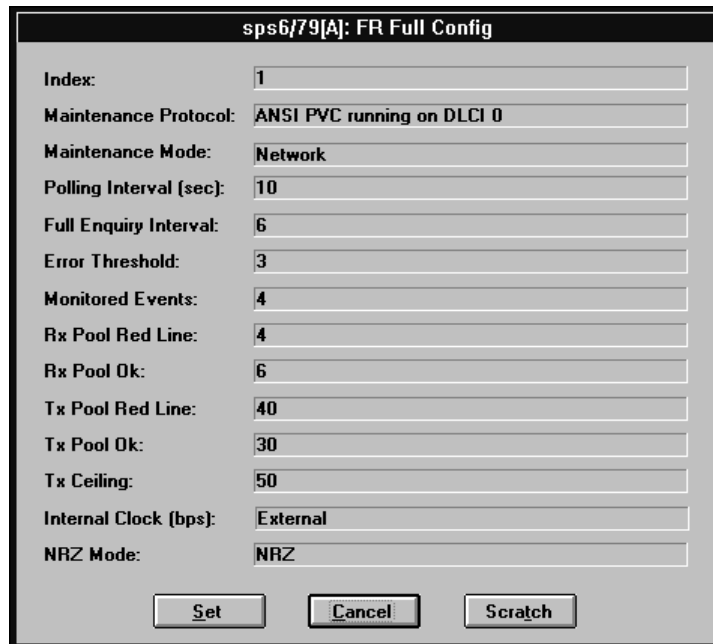

3. In the FR Full Config dialog box, click **Scratch** to switch to the Scratch configuration mode.
4. In the Maintenance Protocol list, click the same protocol as the connected router.
5. In the Maintenance Mode list, click **Network**.
6. In the Internal Clock list, click the baud rate according to your specifications.
7. Change other port parameters according to your specifications or keep their default values. Click **Set**.

➤ **Configure Link 2 as the user side**

1. In the PS View window, double-click the Frame Relay link connected to the Frame Relay network (Link 2). The Link 2 FR window appears.
2. In the FR window, click **FR**. On the **FR Configuration** menu, point to **Parameters** and click **Quick Config**. In the FR Quick Config dialog box, click **Scratch** to switch to the Scratch configuration mode.

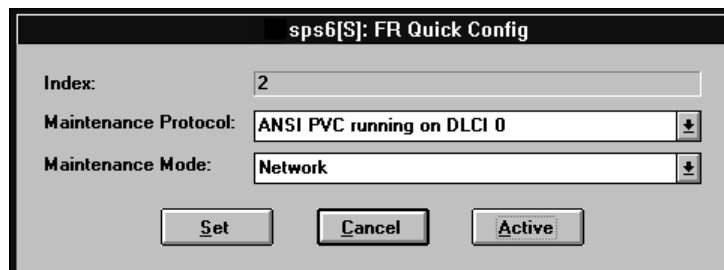

3. In the Maintenance Protocol list, click the same protocol as the Frame Relay network.
4. In the Maintenance Mode list, click **User**. Click **Set**.

**Note**

If you want to change additional port parameters according to your specifications, open the **FR Configuration** menu, point to **Parameters** and click **Full Config** to open the Full Config dialog box.

5. On the **FR Configuration** menu, click **Save**. Click **OK** to confirm.

➤ **Add a DLCI for Link 1**

1. In the Link 1 FR window, click **DLCI**. On the **DLCI Configuration** menu, click **Parameters**.

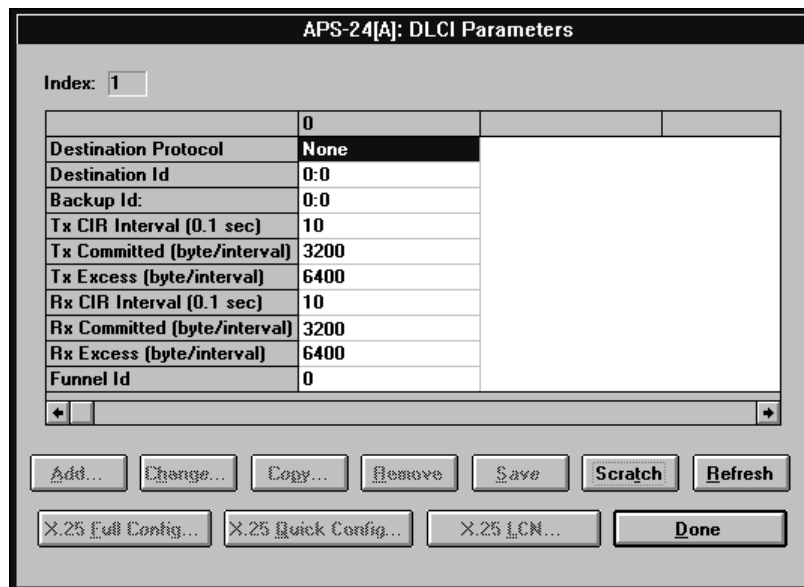

- In the DLCI Parameters table, click **Scratch** to switch to the Scratch configuration mode and then click **Add**.

- The Add DLCI Parameters dialog box appears, displaying the DLCI default values. Click **Set**.

➤ **Add a DLCI for Link 2**

- In the Link 2 FR window, click **DLCI**. See the above procedure, “➤ Add a DLCI for Link 1.” Perform all steps as instructed.

➤ **Configure the Link 1 DLCI**

- In the Link 1 FR window, click **DLCI**. On the DLCI **Configuration** menu, click **Parameters**.

Parameter	Value
Destination Protocol	None
Destination Id	0:0
Backup Id:	0:0
Tx CIR Interval (0.1 sec)	10
Tx Committed (byte/interval)	3200
Tx Excess (byte/interval)	6400
Rx CIR Interval (0.1 sec)	10
Rx Committed (byte/interval)	3200
Rx Excess (byte/interval)	6400
Funnel Id	0

- In the DLCI Parameters table, click **Scratch** to switch to the Scratch configuration mode.
- Click the DLCI that you want to configure and then click **Change**. The Change DLCI Parameters dialog box appears.

4. In the Destination Protocol list, click **None**.
5. In the Destination Id box, type the number of the link connected to the Frame Relay network (Link 2), a colon and the number of the Frame Relay network's DLCI (for example, **2:16** indicates Link 2 and DLCI 16). Click **Set**.
6. In the DLCI Parameters table, click the new DLCI, click **Save** and then click **Entry**.  
To save the complete DLCI table, click **Save** and then click **All**.
7. Close the Link 1 FR window.

➤ **Configure the Link 2 DLCI**

- In the Link 2 FR window, click **DLCI**. See the above procedure, "➤ *Configure the Link 1 DLCI*." Perform steps 1 to 4. Afterwards, perform the following steps:
  1. In the Destination Id box, type the number of the link connected to the router (Link 1), a colon and the router's DLCI number (for example, **1:17** indicates Link 1 and DLCI 17). Click **Set**.
  2. In the DLCI Parameters table, click the new DLCI, click **Save** and then click **Entry**.  
To save the complete DLCI table, click **Save** and then click **All**.
  3. Close the Link 2 FR window.

## 2.14 Backup DLCI

At least one of the packet switch links may be configured as a backup link. If a call cannot pass through the primary link, a backup link provides access to a Frame Relay network.

This example describes the addition of a backup DLCI to the Frame Relay application described in *Frame Relay Network/Frame Relay User*. The configuration procedures include:

- Set the backup link to Frame Relay
- Set the backup link port parameters
- Add and configure a backup DLCI
- Update the main DLCI.

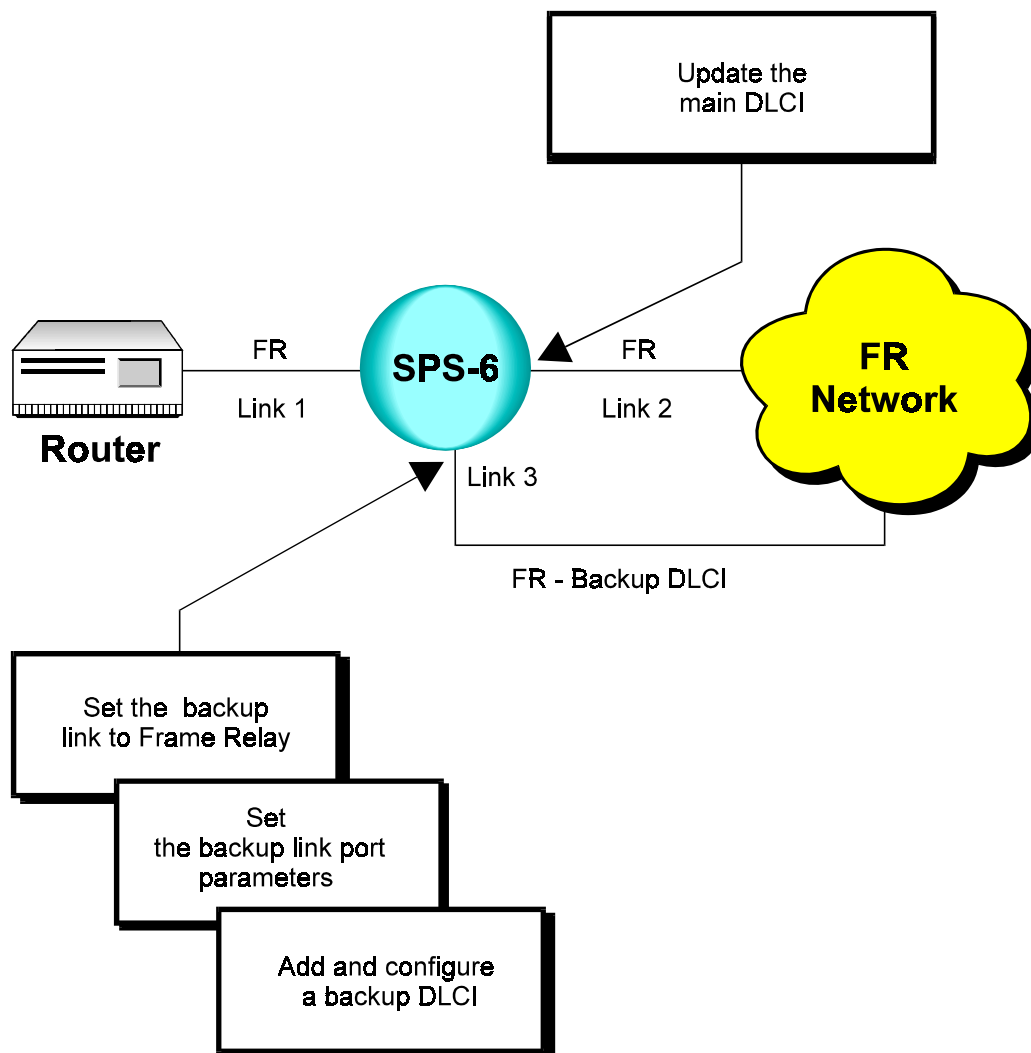



## Terminal Configuration Procedures



This section describes the configuration procedures for adding a backup DLCI to the Frame Relay Network/Frame Relay User application.

### ➤ Set the backup link to Frame Relay

In this application, Link 3 represents the backup link.

- See *Frame Relay Link Configuration, "Terminal Configuration Procedures, ➤ Set a link to Frame Relay."* Perform all steps as instructed.

### ➤ Set the backup link port parameters

- See *Frame Relay Link Configuration, "Terminal Configuration Procedures, ➤ Set the Frame Relay port parameters."* Perform all steps as instructed. It is recommended, but not necessary, to set similar parameters for the backup link as for the main link to the Frame Relay network.

### ➤ Add and configure a backup DLCI

- See *Frame Relay Link Configuration, "Terminal Configuration Procedures, ➤ Add and configure a DLCI."* Perform steps 1 to 4. Afterwards, perform the following steps:

1. In the DLCI xxx Link x Configuration menu, choose **2** (Destination ID). In the Destination ID screen, type the number of the link connected to the router (Link 1), a colon and the router DLCI number (for example, **1:17** indicates Link 1 and DLCI 17).

```

2) Destination id
-----
This field is used only if the Encapsulation Type value is 2 or 4.
Current value ... [0:0 ]

Possible values:
A pair of Port and existing DLCI, with Encapsulation Type value 2.
An existing Async. Channel, if the Encapsulation Type of
this DLCI is 4.

Enter one of the above values or <RETURN> to exit:

```

2. Change other DLCI parameters according to your network specifications or keep their default values. Choose **S** to save the configuration.

### ➤ Update the main DLCI

1. Press ENTER several times so that the Link Configuration menu reappears. In the Link Configuration menu, choose **3** (Update Link Parameters).

```

Link configuration
-----
1) Set Link type.
2) Display Links protocols.
3) Update Link parameters.
4) Display Links parameters.
CR) Exit

Select:

```

- Choose the number of the link that connects the packet switch to the Frame Relay network (Link 2).

Link	1	2	3	4	5	6
Prot	FR	FR	FR	X.25	X.25	X.25

Enter Link number to update:

- In the Frame Relay Link x Configuration menu, choose **4** (Update DLCI Parameters).

```

FRAME RELAY Link 2      configuration
-----
1) Add DLCI.
2) Delete DLCI.
3) Update PORT parameters.
4) Update DLCI parameters.
CR) Exit

Select:

```

- In the DLCI xxx Link x Configuration menu, choose **3** (Backup DLCI).

```

DLCI 100   Link 3      configuration
-----
1) Encapsulation Type ..... [2   ]
2) Destination Id ..... [0:0  ]
3) Backup DLCI ..... [0:0  ]
4) Tx Tc (1/10 Sec) ..... [10  ]
5) Tx Bc (Bytes per Tx Tc) ..... [65000]
6) Tx Be (Bytes per Tx Tc) ..... [65000]
7) Rx Tc (1/10 Sec) ..... [10  ]
8) Rx Bc (Bytes per Rx Tc) ..... [65000]
9) Rx Be (Bytes per Rx Tc) ..... [65000]
10) Funnel id ..... [0   ]
11) Tx Priority ..... [0   ]
12) ISDN Destination ..... [0   ]
S) Save
CR) Exit

Select:

```

- In the Backup DLCI screen, type the link number of the backup DLCI, a colon and the backup DLCI number (for example, **3:20** indicates Link 3 and DLCI 20).

```

3) Backup DLCI
-----
The backup DLCI, which will be used when this DLCI goes inactive.
Current value ... [0:0  ]

Possible values:
  An existing DLCI, with the same destination protocol and
  destination id like this DLCI.

Enter one of the above values or <RETURN> to exit:

```

- Change other DLCI parameters according to your network specifications or keep their default values. Choose **S** to save the configuration.

## RADview Configuration Procedures



The following are the RADview steps that describe the addition of a backup DLCI to the Frame Relay Network/Frame Relay User application

### ➤ Set the backup link to Frame Relay

In this application, Link 3 represents the backup link.

- See *Frame Relay Link Configuration*, “RADview Configuration Procedures, ➤ *Set a link to Frame Relay.*” Perform all steps as instructed.

### ➤ Set the backup link port parameters

- See *Frame Relay Link Configuration*, “RADview Configuration Procedures, ➤ *Set the Frame Relay port parameters.*” Perform all steps as instructed. It is recommended, but not necessary, to set similar parameters for the backup link as for the main link to the Frame Relay network.

### ➤ Add and configure a backup DLCI

1. In the Link 3 FR window, click **DLCI**. On the **DLCI Configuration** menu, click **Parameters**.

sps6 [A]: DLCI Parameters

Index:

	0		
Destination Protocol	None		
Destination Id	0:0		
Backup Id:	0:0		
Tx CIR Interval (0.1 sec)	10		
Tx Committed (byte/interval)	3200		
Tx Excess (byte/interval)	6400		
Rx CIR Interval (0.1 sec)	10		
Rx Committed (byte/interval)	3200		
Rx Excess (byte/interval)	6400		
Funnel Id	0		

- In the DLCI Parameters table, click **Scratch** to switch to the Scratch configuration mode and then click **Add**.

The screenshot shows a dialog box titled "Add: DLCI Parameters<1>". It contains the following fields and values:

DLCI Index:	16
Destination Protocol:	None
Destination Id:	0:0
Backup Id:	0:0
Tx CIR Interval (0.1 sec):	10
Tx Committed (byte/interval):	3200
Tx Excess (byte/interval):	6400
Rx CIR Interval (0.1):	10
Rx Committed (byte/interval):	3200
Rx Excess (byte/interval):	6400
Funnel Id:	0

At the bottom of the dialog are two buttons: "Set" and "Cancel".

- The Add DLCI Parameters dialog box appears. In the Destination Protocol list, click **None**.
- In the Destination Id box, type the number of the link connected to the router (Link 1), a colon and the router DLCI number (for example, **1:17** indicates Link 1 and DLCI 17).
- Change other DLCI parameters according to your network specifications or keep their default values. Click **Set**.
- In the DLCI Parameters table, click the new DLCI, click **Save** and then click **Entry**.  
To save the complete DLCI table, click **Save** and then click **All**.
- Close the Link 3 FR window.

➤ **Update the main DLCI**

- In the PS View window, double-click the main link to the Frame Relay network (Link 2). The Link 2 FR window appears.
- In the Link 2 FR window, click **DLCI**. On the DLCI **Configuration** menu, click **Parameters**.

- In the DLCI Parameters table, click **Scratch** to switch to the Scratch configuration mode. Click the DLCI that you want to update and click **Change**. The Change DLCI Parameters dialog box appears.

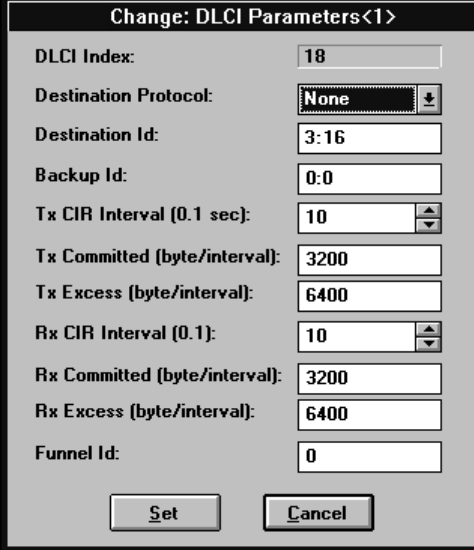

The image shows a dialog box titled "Change: DLCI Parameters<1>". It contains several input fields and buttons. The fields are: DLCI Index (18), Destination Protocol (None), Destination Id (3:16), Backup Id (0:0), Tx CIR Interval (0.1 sec) (10), Tx Committed (byte/interval) (3200), Tx Excess (byte/interval) (6400), Rx CIR Interval (0.1) (10), Rx Committed (byte/interval) (3200), Rx Excess (byte/interval) (6400), and Funnel Id (0). There are "Set" and "Cancel" buttons at the bottom.

- In the Backup ID box, type the link number of the backup DLCI, a colon and the backup DLCI number (for example, **3:16** indicates Link 3 and DLCI 16). Click **Set**.
- In the DLCI Parameters table, click the updated DLCI, click **Save** and then click **Entry**.  
To save the complete DLCI table, click **Save** and then click **All**.

## 2.15 X.25 Over Frame Relay

Transferring data through Asynchronous channels over a Frame Relay network using encapsulated X.25 protocol.

This section describes configuration procedures for an X.25 over Frame Relay application. These procedures include:

- Set a link to Frame Relay
- Set the Frame Relay port parameters
- Add and configure a DLCI
- Set X.25 encapsulation parameters for the Frame Relay link
- Add a routing table entry
- Configure an X.28 (Asynchronous) channel that connects to a terminal.

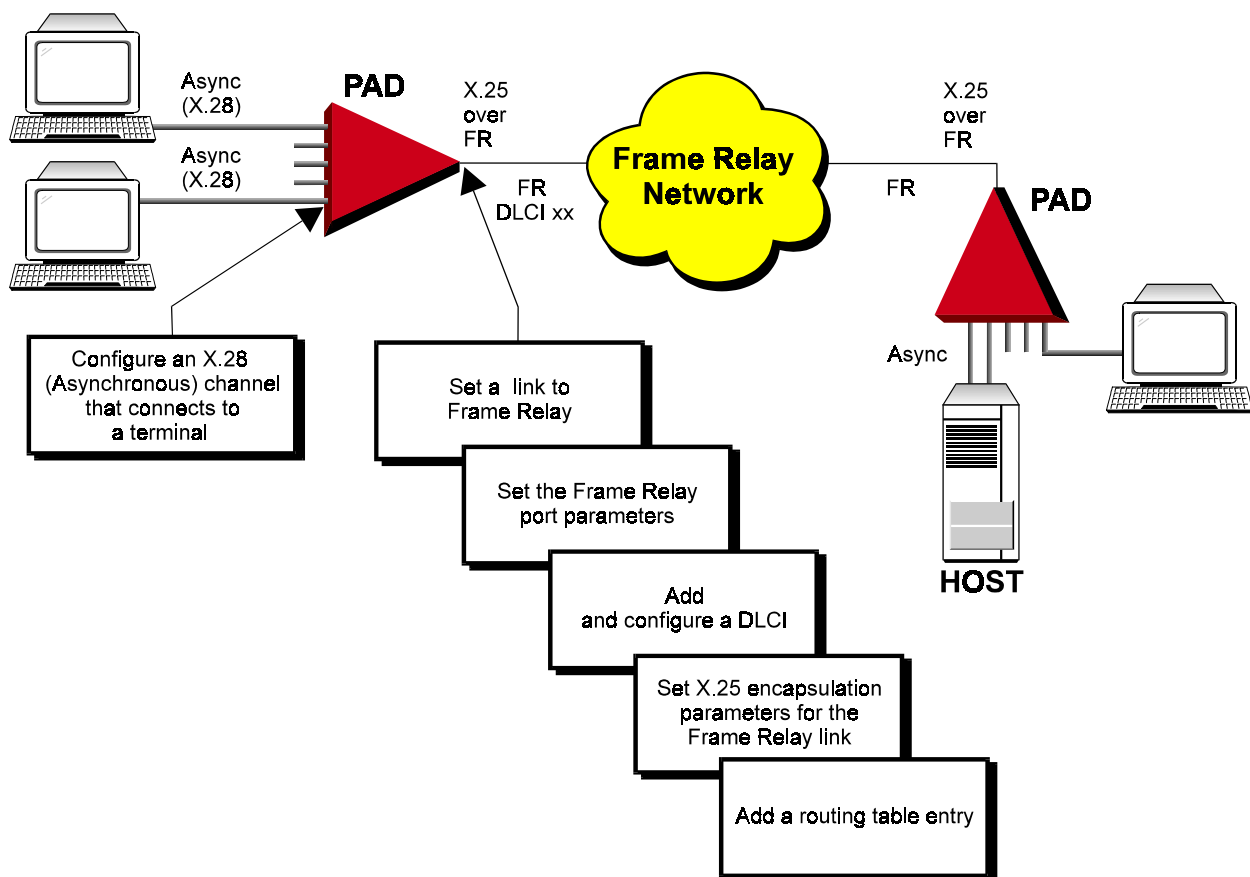

## Terminal Configuration Procedure



The following steps describe the terminal configuration procedures for an X.25 over Frame Relay application.

### ➤ Set a link to Frame Relay

- See *Frame Relay Link Configuration, "Terminal Configuration Procedures, ➤ Set a link to Frame Relay."* Perform all steps as instructed.

### ➤ Set the Frame Relay port parameters

- See *Frame Relay Link Configuration, "Terminal Configuration Procedures, ➤ Set the Frame Relay port parameters."* Perform steps 1 to 5 of the procedure. Afterwards, perform the following steps:

1. In the Maintenance Protocol Mode screen, choose **0** (User-side).

```

2) Maintenance protocol mode
-----
This field defines the mode of maintenance protocol running
over this port.
Current value ... [1    ]

Possible values:
0 - Perform user-side procedure on this port.
1 - Perform network-side procedure on this port.
2 - Perform NNI (Network to Network Interface) procedure
   on this port.

Enter one of the above values or <RETURN> to exit:

```

2. In the Frame Relay Port x Configuration menu, change other port parameters according to your network specifications or keep their default values. Choose **S** to save the configuration.

### ➤ Add and configure a DLCI

- See *Frame Relay Link Configuration, "Terminal Configuration Procedures, ➤ Add and configure a DLCI."* Perform steps 1 to 3 of the procedure. Afterwards, perform the following steps:

1. In the Encapsulation Type screen, choose **1** (X.25 Encapsulation).

```

1) Encapsulation Type
-----
Current value ... [2    ]

Possible values:
1 - X25 encapsulation.
2 - No protocol encapsulation.
3 - Transparent HDLC encapsulation.
4 - Asynchronous encapsulation.
5 - Multi Point Encapsulation.
6 - RFC1490 encapsulation.
7 - Multicast

Enter one of the above values or <RETURN> to exit:

```

2. Change other DLCI parameters according to your network specifications or keep their default values. Choose **S** to save the configuration.

➤ **Set X.25 encapsulation parameters for the Frame Relay link**

1. Press ENTER several times so that the DLCI xxx Link x menu reappears. In the DLCI xxx Link x menu, choose **2** (Update X.25 Configuration).

```

DLCI 100   Link 3
-----
1) Update DLCI configuration.
2) Update X25 configuration.
CR) Exit

Select:

```

2. In the X.25 Link x DLCI xxx Configuration menu, choose **2** (DCE/DTE).

```

X.25 Link 3 DLCI 100 configuration
-----
1) Address ..... [0 ] 17) LGN ..... [0 ]
2) DCE (1) / DTE (0)..... [1 ] 18) Lowest LCN (LIC) ..... [1 ]
3) Extended mode ..... [0 ] 19) Amount of Incoming LCNs .. [5 ]
4) T1 ..... [5 ] 20) Amount of Two Way LCNs ... [5 ]
5) T3 ..... [20 ] 21) Amount of Outgoing LCNs .. [5 ]
6) N2 ..... [10 ] 22) Internal Clock ..... [0 ]
7) k ..... [7 ] 23) LINE option ..... [1024 ]
8) w ..... [2 ] 24) Segment Size..... [128 ]
9) T10 ..... [18 ] 25) Xid num ..... [0 ]
10) T11 ..... [20 ] 26) NUI Group ID ..... [0 ]
11) T12 ..... [18 ] 27) Physical interface option. [0 ]
12) T13 ..... [18 ] 28) X.25 Acknowledge Counter . [1 ]
13) Packet size ..... [128 ] 29) X.25 Acknowledge Timer ... [0 ]
14) In call options ..... [1 ] 30) LAPB Acknowledge Counter . [1 ]
15) Out call options ..... [1 ] 31) LAPB Acknowledge Timer ... [0 ]
16) Subaddress length ..... [2 ] 32) CUG subscription ..... [5 ]
S) Save
CR) Exit

Select:

```

3. In the DCE/DTE screen, choose an option number according to your network specifications.

**Note**

*The DCE/DTE setting for this device must be the direct opposite of the DCE/DTE setting for its corresponding device on the other side of the Frame Relay network. For example, if this device is X.25 DTE, the corresponding device must be X.25 DCE.*

```

2) DCE/DTE
-----
Current value ... [1 ]

Possible values:
0 - The link appears as a X25 DTE.
1 - The link appears as a X25 DCE.
2 - The link is X25->DCE and LAPB->DTE.
3 - The link is X25->DTE and LAPB->DCE.

Enter one of the above values or <RETURN> to exit:

```



4. In the X.25 Link x DLCI xxx Configuration menu, choose **8** (W). In the W screen, type the W value according to your specifications.

```

      8) w
      -----
      Packet window size.
      Current value ... [2    ]

      Possible values:
      1 - 7   : for operation in basic mode.
      1 - 127 : for operation in extended mode.

      Enter one of the above values or <RETURN> to exit:
  
```

5. In the X.25 Link x DLCI xxx Configuration menu, choose **13** (Packet Size). In the Packet Size screen, choose the Packet Size value according to your specifications.

```

     13) Packet size
     -----
     Current value ... [128  ]

     Possible values:
     0 - 4096
     frequent values are:
     128,256,512,1024,2048,4096

     Enter one of the above values or <RETURN> to exit:
  
```

6. Change other X.25 parameters according to your network specifications or keep their default values. In the X.25 Link x DLCI xxx Configuration menu, choose **S** to save the configuration.

➤ **Add a routing table entry**

- See *X.25 Link Configuration, "Terminal Configuration Procedures, ➤ Add a routing table entry."* Perform steps 1 to 3 of the procedure. Afterwards, perform the following steps:

1. In the Destination Link screen, type the number of the link connecting the device to the Frame Relay network (Link 1), a colon and the number of any valid DLCI on that link that includes X.25 encapsulation (for example, **1:18** indicates Link 1 and DLCI 18).

```

      1) Destination link
      -----
      Current value ... [1    ]

      Possible values:
      L - local channel.
      Any valid X.25 link number.
      Any valid FRAME RELAY DLCI with an X.25 destination protocol,
      the DLCI is presented in the form of {port:DLCI}
      ISDN routing entry number preceded by the letter 'I' (i.e.: I5)

      Enter one of the above values or <RETURN> to exit:
  
```

- In the Routing Table Entry x Configuration menu, choose **4** (Address). In the Address screen, type the address of the packet switching device on the other side of the Frame Relay network.

```

4) Address
-----
Current value ... [      ]

Possible values:
Up to 15 decimal digits or X (don't care) digits.

Enter one of the above values or <RETURN> to exit:

```

- In the Routing Table Entry x Configuration menu, choose **S** to save the configuration.

➤ **Configure an X.28 (Asynchronous) channel that connects to a terminal**

- See *Asynchronous Channel Configuration, "Terminal Configuration Procedures."* Perform all steps as instructed.

**Note**

*The Asynchronous channel may use either X.28 or SLIP protocol.*

## RADview Configuration Procedures



The following steps describe the RADview configuration procedures for an X.25 over Frame Relay application.

➤ **Set a link to Frame Relay**

- See *Frame Relay Link Configuration, "RADview Configuration Procedures, ➤ Set a link to Frame Relay."* Perform all steps as instructed.

➤ **Set the Frame Relay port parameters**

- In the PS View window, double-click the Frame Relay link. The FR window appears.

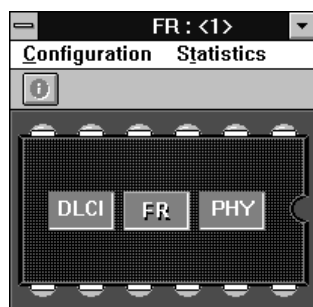

- In the FR window, click **FR**. On the **FR Configuration** menu, point to **Parameters** and click **Quick Config**. In the FR Quick Config dialog box, click **Scratch** to switch to the Scratch configuration mode.

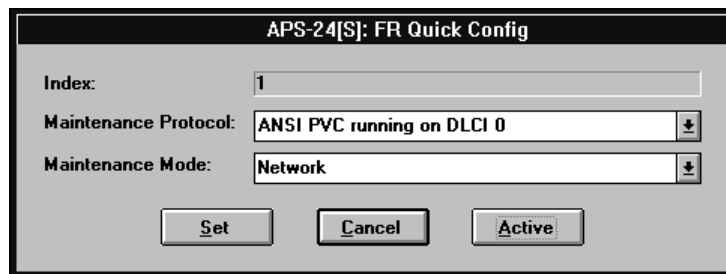

- In the Maintenance Mode list, click **User**. Click **Set**.

**Note** *If you want to change additional port parameters according to your specifications, open the **FR Configuration** menu, point to **Parameters** and click **Full Config** to open the Full Config dialog box.*

- On the **FR Configuration** menu, click **Save**. Click **OK** to confirm.

#### ➤ Add and configure a DLCI

- See *Frame Relay Link Configuration, "RADview Configuration Procedures, ➤ Add and configure a DLCI."* Perform steps 1 and 2 of the procedure. Afterwards, perform the following step:

- The Add DLCI Parameters dialog box appears. In the Destination Protocol list, click **X.25**. Change other DLCI parameters according to your network specifications or keep their default values. Click **Set**.

#### ➤ Set X.25 encapsulation parameters for the Frame Relay link

- In the DLCI Parameters table, click **X.25 Quick Config**.
- In the Quick Config dialog box, click **Scratch** to switch to the Scratch configuration mode. In the DCE-DTE list, click **DTE**.

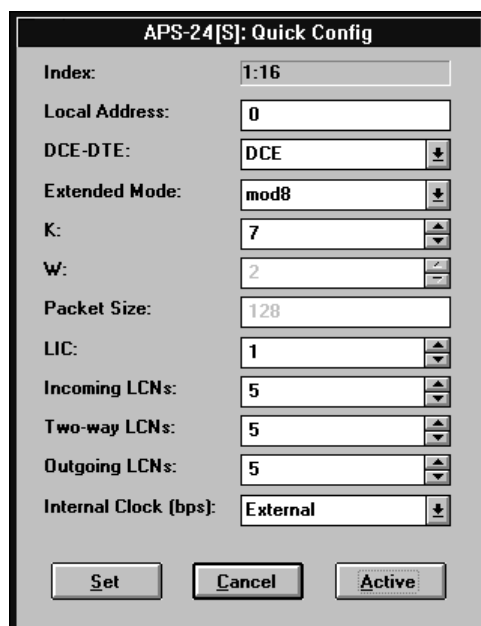

3. Change other X.25 parameters according to your network specifications or keep their default values. Click **Set**.
4. In the DLCI Parameters table, click the new DLCI, click **Save** and then click **Entry**.  
To save the complete DLCI table, click **Save** and then click **All**.
5. Close the FR window and click in the PS View without clicking a link. On the **Configuration** menu, point to **Sync Global Param, Call Definition** and click **X.25 Call Parameters**.

Index:	Reference Count:	Packet Size(byte):	W:	Accept Reverse Charge:
1	12	128	2	Refuse

6. In the X.25 Call Parameters table, click **Add**.

7. In the Add X.25 Call Parameters dialog box, set the Packet Size and W parameters according to your specifications. Click **Set**.
8. In the X.25 Call Parameters table, click **Refresh** to display the new set of parameters in the table.

➤ **Add a routing table entry**

- See *X.25 Link Configuration, "RADview Configuration Procedures, ➤ Add a routing table entry."* Perform the procedure as instructed except for step 4. Perform step 4 as follows:

1. In the Destination Link 1 box, type the number of the link connecting the device to the Frame Relay network (Link 1), a colon and the number of any valid DLCI on that link that includes X.25 encapsulation (for example, **1:18** indicates Link 1 and DLCI 18).

➤ **Configure an Asynchronous channel that connects to a terminal**

- See *Asynchronous Channel Configuration, "RADview Configuration Procedures."* Perform all steps as instructed.

---

---

## 2.16 ISDN Backup Link (Frame Relay Network)

In this application, at least one of the packet switch links may be configured as a backup link. If a call cannot pass through the primary link, a backup link can provide connection to another packet switch over an ISDN network. When the primary link returns to normal operation, the ISDN link disconnects and communication resumes through the primary link.

This section describes the configuration procedures for a Frame Relay backup link between two packet switches (in this example, SPS-6 and APS-8) through an ISDN network. The configuration procedures for *both* packet switches include:

- Set link 3 and link 1 to Frame Relay
- Configure Link 3 as the user side
- Add a DLCI for Link 3
- Configure the Link 3 DLCI
- Set the ISDN routing parameters
- Configure Link 1 as the network side (SPS-6 only)
- Configure Link 1 as the user side (APS-8 only)
- Add a DLCI for Link 1
- Configure the Link 1 DLCI
- Update the Link 3 DLCI.

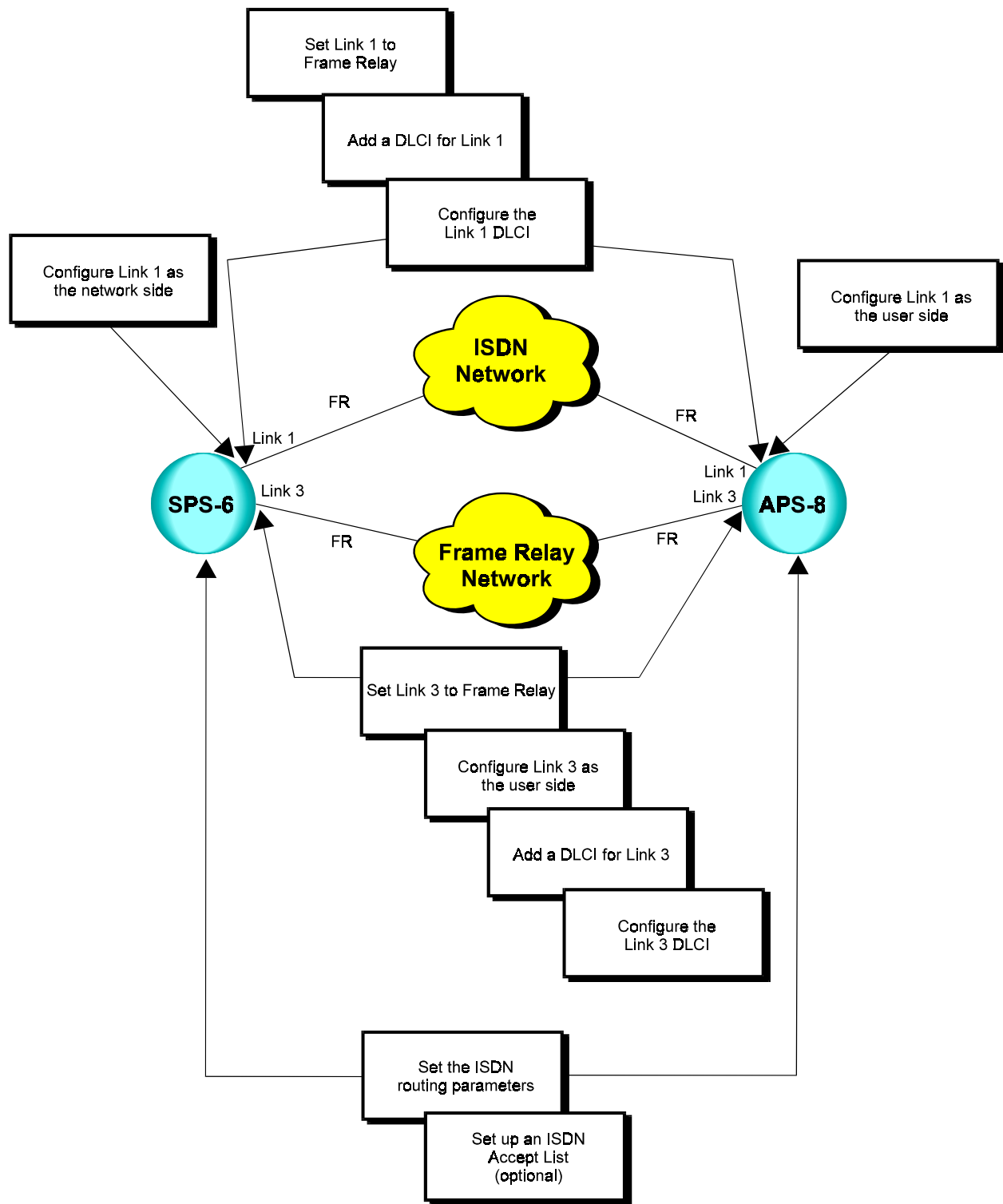

## Terminal Configuration Procedures



This section describes the configuration procedures for a Frame Relay backup link between two packet switches through an ISDN network.

### Note

This application requires prior installation of a MOBI interface card in the following synchronous links, depending on the packet switch models used in your application:

For SPS-12 - link nos. 1 & 2 and/or 7 & 8.

For APD-8 - link no. 1.

For SPS-3S and APS devices - link no. 1 and/or 2.

For FPS-8 - any link

### ➤ Set link 3 and link 1 to Frame Relay (SPS-6)

In the SPS-6, link 3 connects to the APS-8 over a Frame Relay network and link 1 is the backup link to the APS-8 over an ISDN network.

- Select link 3 and link 1 of the SPS-6 and set their link types to Frame Relay. See *Frame Relay Link Configuration, "Terminal Configuration Procedures, ➤ Set a link to Frame Relay."* Perform all steps as instructed for each link.

### ➤ Configure Link 3 as the user side (SPS-6)

- See *Frame Relay Link Configuration, "Terminal Configuration Procedures, ➤ Set the Frame Relay port parameters."* Perform steps 1 to 5 of the procedure. Afterwards, perform the following steps:

1. In the Maintenance Protocol Mode screen, choose **0** (User-side).

```

2) Maintenance protocol mode
-----
This field defines the mode of maintenance protocol running
over this port.
Current value ... [1    ]

Possible values:
0 - Perform user-side procedure on this port.
1 - Perform network-side procedure on this port.
2 - Perform NNI (Network to Network Interface) procedure
   on this port.

Enter one of the above values or <RETURN> to exit:

```

2. In the Frame Relay Port x Configuration menu, change other port parameters according to your network specifications or keep their default values. Choose **S** to save the configuration.

➤ **Add a DLCI for Link 3 (SPS-6)**

1. Press **ENTER** several times so that the Link Configuration menu reappears. In the Link Configuration menu, choose **3** (Update Link Parameters).

```

Link configuration
-----
1) Set Link type.
2) Display Links protocols.
3) Update Link parameters.
4) Display Links parameters.
CR) Exit

Select:

```

2. Choose the number of the Frame Relay link connected to the Frame Relay network (Link 3).

```

Link | 1 | 2 | 3 | 4 | 5 | 6 |
-----|-----|-----|-----|-----|-----|
Prot | FR | X.25 | FR | X.25 | X.25 | X.25 |

Enter Link number to update:

```

3. In the Frame Relay Link x Configuration menu, choose **1** (Add DLCI).

```

FRAME RELAY Link 3 configuration
-----
1) Add DLCI.
2) Delete DLCI.
3) Update PORT parameters.
4) Update DLCI parameters.
CR) Exit

Select:

```

Type a number for the new DLCI (**16** to **991**).

➤ **Configure the Link 3 DLCI (SPS-6)**

1. Press **ENTER** several times so that the Link Configuration menu reappears. In the Link Configuration menu, choose **3** (Update Link Parameters).
2. Choose the number of the Frame Relay link connected to the Frame Relay network (Link 3).
3. In the Frame Relay Link x Configuration menu, choose **4** (Update DLCI Parameters).

```

FRAME RELAY Link 3 configuration
-----
1) Add DLCI.
2) Delete DLCI.
3) Update PORT parameters.
4) Update DLCI parameters.
CR) Exit

Select:

```



4. In the DLCI xxx Link x menu, choose **1** (Update DLCI Configuration).

```

DLCI 16  Link 3
-----
1) Update DLCI configuration.
2) Update X25 configuration.
CR) Exit

Select:

```

5. In the DLCI xxx Link x Configuration menu, choose **1** (Encapsulation Type).

```

DLCI 16  Link 3  configuration
-----
1) Encapsulation Type ..... [2  ]
2) Destination Id ..... [0:0  ]
3) Backup DLCI ..... [0:0  ]
4) Tx Tc (1/10 Sec) ..... [10  ]
5) Tx Bc (Bytes per Tx Tc) ..... [65000]
6) Tx Be (Bytes per Tx Tc) ..... [65000]
7) Rx Tc (1/10 Sec) ..... [10  ]
8) Rx Bc (Bytes per Rx Tc) ..... [65000]
9) Rx Be (Bytes per Rx Tc) ..... [65000]
10) Funnel id ..... [0  ]
11) Tx Priority ..... [0  ]
12) ISDN Destination ..... [0  ]
S) Save
CR) Exit

Select:

```

6. In the Encapsulation Type screen, choose **2** (No Protocol Encapsulation).

```

1) Encapsulation Type
-----
Current value ... [2  ]

Possible values:
1 - X25 encapsulation.
2 - No protocol encapsulation.
3 - Transparent HDLC encapsulation.
4 - Asynchronous encapsulation.
5 - Multi Point Encapsulation.
6 - RFC1490 encapsulation.
7 - Multicast

Enter one of the above values or <RETURN> to exit:

```

7. In the DLCI xxx Link x Configuration menu, choose **2** (Destination ID).  
In the Destination ID screen, type the number of the link connecting to the Frame Relay network (Link 3), a colon and the DLCI number of the Frame Relay network (for example, **3:16** indicates Link 3 and DLCI 16).

```

2) Destination id
-----
This field is used only if the Encapsulation Type value is 2 or 4.
Current value ... [0:0  ]

Possible values:
A pair of Port and existing DLCI, with Encapsulation Type value 2.
An existing Async. Channel, if the Encapsulation Type of
this DLCI is 4.

Enter one of the above values or <RETURN> to exit:

```

8. Change other DLCI parameters according to your network specifications or keep their default values. Choose **S** to save the configuration.

➤ **Set the ISDN routing parameters (SPS-6)**

1. Press ENTER several times so that the Configuration menu reappears. In the Configuration menu, choose **15** (ISDN Configuration).

```
Configuration menu
-----
1) Channel
2) Profile
3) Link
4) System parameters
5) PVC
6) Call ID
7) NUI
8) Alias
9) Routing table
10) Funnel
11) X.32
12) Management
13) Multicast
14) IP configuration
15) ISDN configuration
16) SNA
CR) Exit

Select:
```

2. In the ISDN Configuration menu, choose **2** (ISDN Routing Table).

```
ISDN configuration
-----
1) Global Configuration.
2) ISDN Routing Table.
3) ISDN Accept List Table.
4) Update ISDN Link Parameters.
5) Display ISDN Link Parameters.
CR) Exit.

Select:
```

3. In the ISDN Routing Configuration menu, choose **1** (Add ISDN Routing Entry).

```
ISDN Routing Configuration
-----
1) Add ISDN Routing Entry
2) Delete ISDN Routing Entry
3) Update ISDN Routing Entry
4) Display ISDN Routing Entry
CR) Exit

Select:
```

Type **1** as the ISDN Routing number and press ENTER.

4. In the ISDN Routing Entry x Configuration menu, choose **1** (Outgoing Address).

```

ISDN routing entry 1 configuration
-----
1) Outgoing Address ..... [    ]
2) Outgoing Subaddress ..... [    ]
3) Alternate Address 1 ..... [    ]
4) Alternate Subaddress 1 ..... [    ]
5) Alternate Address 2 ..... [    ]
6) Alternate Subaddress 2 ..... [    ]
7) ISDN Speed..... [1    ]
8) Options ..... [0    ]
S) Save.
CR) Exit.

Select:

```

5. In the Outgoing Address screen, type the ISDN phone number of the APS-8 (for example, **6451234**).

```

1) Outgoing address
-----

Current value ... [    ]

Possible values:
Up to 17 decimal digits.

Enter one of the above values or <RETURN> to exit:

```

6. In the ISDN Routing Entry x Configuration menu, choose **S** to save the configuration.

➤ **Configure Link 1 as the network side (SPS-6)**

- See *Frame Relay Link Configuration, "Terminal Configuration Procedures, ➤ Set the Frame Relay port parameters."* Perform steps 1 to 5 of the procedure. Afterwards, perform the following steps:

1. In the Maintenance Protocol Mode screen, choose **1** (Network-side).

```

2) Maintenance protocol mode
-----

This field defines the mode of maintenance protocol running
over this port.
Current value ... [1    ]

Possible values:
0 - Perform user-side procedure on this port.
1 - Perform network-side procedure on this port.
2 - Perform NNI (Network to Network Interface) procedure
on this port.

Enter one of the above values or <RETURN> to exit:

```

2. In the Frame Relay Port x Configuration menu, change other port parameters according to your network specifications or keep their default values. Choose **S** to save the configuration.

➤ **Add a DLCI for Link 1 (SPS-6)**

- Repeat the procedure, “➤ *Add a DLCI for Link 3 (SPS-6)*,” earlier in this section. In step 2, choose the number of the Frame Relay link connected to the ISDN network (Link 1).

➤ **Configure the Link 1 DLCI (SPS-6)**

- See the procedure, “➤ *Configure the Link 3 DLCI (SPS-6)*,” earlier in this section. Perform steps 1 to 7. In step 2, choose the number of the Frame Relay link connected to the ISDN network (Link 1). Afterwards, perform the following steps:

1. In the DLCI xxx Link x Configuration menu, choose **12** (ISDN Destination Id).

```

DLCI 17  Link 1  configuration
-----
1) Encapsulation Type ..... [2   ]
2) Destination Id ..... [0:0  ]
3) Backup DLCI ..... [0:0  ]
4) Tx Tc (1/10 Sec) ..... [10  ]
5) Tx Bc (Bytes per Tx Tc) ..... [65000]
6) Tx Be (Bytes per Tx Tc) ..... [65000]
7) Rx Tc (1/10 Sec) ..... [10  ]
8) Rx Bc (Bytes per Rx Tc) ..... [65000]
9) Rx Be (Bytes per Rx Tc) ..... [65000]
10) Funnel id ..... [0   ]
11) Tx Priority ..... [0   ]
12) ISDN Destination ..... [0   ]
S) Save
CR) Exit

Select:

```

2. In the ISDN Destination Id screen, type **1** as the ISDN routing number (see the procedure, “➤ *Set the ISDN routing parameters (SPS-6)*,” step 3, earlier in this section).

```

12) ISDN destination id
-----
The ISDN routing id attached to this DLCI
Current value ... [0   ]

Possible values:
Any valid ISDN routing entry.

Enter one of the above values or <RETURN> to exit:

```

3. Change other DLCI parameters according to your network specifications or keep their default values. Choose **S** to save the configuration.

➤ **Update the Link 3 DLCI (SPS-6)**

- See the procedure, “➤ *Configure the Link 3 DLCI (SPS-6)*,” earlier in this section. Perform steps 1 to 4 of the procedure. Afterwards, perform the following steps:

1. In the DLCI xxx Link x Configuration menu, choose **3** (Backup DLCI).

```

DLCI 17 Link 1 configuration
-----
1) Encapsulation Type ..... [2 ]
2) Destination Id ..... [0:0 ]
3) Backup DLCI ..... [0:0 ]
4) Tx Tc (1/10 Sec) ..... [10 ]
5) Tx Bc (Bytes per Tx Tc) ..... [65000]
6) Tx Be (Bytes per Tx Tc) ..... [65000]
7) Rx Tc (1/10 Sec) ..... [10 ]
8) Rx Bc (Bytes per Rx Tc) ..... [65000]
9) Rx Be (Bytes per Rx Tc) ..... [65000]
10) Funnel id ..... [0 ]
11) Tx Priority ..... [0 ]
12) ISDN Destination ..... [0 ]
S) Save
CR) Exit

Select:

```

2. In the Backup DLCI screen, type **1** as the link number of the backup DLCI, a colon and the backup DLCI number (for example, **1:18** indicates Link 1 and DLCI 18).

```

3) Backup DLCI
-----
The backup DLCI, which will be used when this DLCI goes inactive.
Current value ... [0:0 ]

Possible values:
An existing DLCI, with the same destination protocol and
destination id like this DLCI.

Enter one of the above values or <RETURN> to exit:

```

3. In the DLCI xxx Link x Configuration menu, choose **S** to save the configuration.

➤ **Set link 3 and link 1 to Frame Relay (APS-8)**

In the APS-8, link 3 connects to the SPS-6 over a Frame Relay network and link 1 is the backup link to the SPS-6 over an ISDN network.

- Select link 3 and link 1 of the APS-8 and set their link types to Frame Relay. See *Frame Relay Link Configuration, “Terminal Configuration Procedures, ➤ Set a link to Frame Relay.”* Perform all steps as instructed for each link.

➤ **Configure Link 3 as the user side (APS-8)**

- Repeat the procedure, “➤ *Configure Link 3 as the user side (SPS-6)*,” earlier in this section. Perform all steps as instructed.

- **Add a DLCI for Link 3 (APS-8)**
  - Repeat the procedure, “➤ *Add a DLCI for Link 3 (SPS-6)*,” earlier in this section. Perform all steps as instructed.
- **Configure the Link 3 DLCI (APS-8)**
  - Repeat the procedure, “➤ *Configure the Link 3 DLCI (SPS-6)*,” earlier in this section. Perform all steps as instructed.
- **Set the ISDN routing parameters (APS-8)**
  - See the procedure, “➤ *Set the ISDN routing parameters (SPS-6)*,” earlier in this section. Perform steps 1 to 4 as instructed. Afterwards, perform the following steps:
    1. In the Outgoing Address screen, type the ISDN phone number of the SPS-6.
    2. In the ISDN Routing Entry x Configuration menu, choose **S** to save the configuration.
- **Configure Link 1 as the user side (APS-8)**
  - Repeat the procedure, “➤ *Configure Link 3 as the user side (SPS-6)*,” earlier in this section. Perform all steps as instructed.
- **Add a DLCI for Link 1 (APS-8)**
  - Repeat the procedure, “➤ *Add a DLCI for Link 3 (SPS-6)*,” earlier in this section. In step 2, choose the number of the Frame Relay link connected to the ISDN network (Link 1).
- **Configure the Link 1 DLCI (APS-8)**
  - Repeat the procedure, “➤ *Configure the Link 1 DLCI (SPS-6)*,” earlier in this section. Perform all steps as instructed.
- **Update the Link 3 DLCI (APS-8)**
  - Repeat the procedure, “➤ *Update the Link 3 DLCI (SPS-6)*,” earlier in this section. Perform all steps as instructed.
- **Set up an ISDN Accept List (optional for both packet switches)**
  - See *ISDN Backup Link (X.25 Network)*, “*Terminal Configuration Procedures*,” ➤ *Set up an ISDN Accept List*.” Perform all steps as instructed.

## 2.17 Frame Relay Multicast

Transferring identical data from a host computer to several locations simultaneously over a Frame Relay network.

In this application, data is being broadcast from the host computer on DLCI 100 along Link 1 of the FPS-8. The FPS-8 duplicates the data as many times as necessary and multicasts the data over a Frame Relay network to several destinations. The application includes a broadcast DLCI, a one-way DLCI, and a two-way DLCI.

This section describes configuration procedures of a packet switching device (not applicable to PADs) in a Frame Relay Multicast application. These procedures include:

- Set four links to Frame Relay
- Configure Link 1 as the network side
- Configure Links 2, 3 and 4 as the user side
- Create and configure a source DLCI on Link 1
- Create and configure a broadcast DLCI on Link 2
- Create and configure a one-way DLCI on Link 3
- Create and configure a two-way DLCI on Link 4.

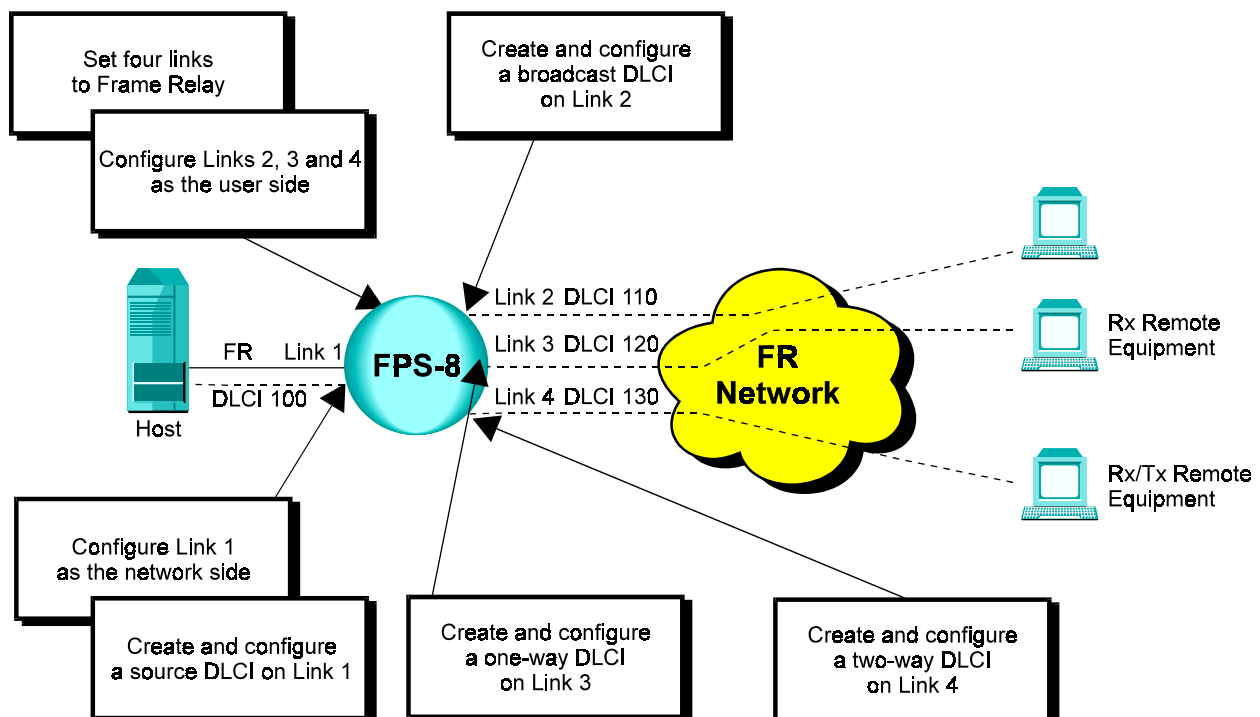

## Terminal Configuration Procedures



This section describes configuration procedures of a packet switching device in a Frame Relay Multicast application.

### ► Set four links to Frame Relay

In this application, link 1 connects to a host computer and links 2, 3 and 4 connect to a Frame Relay network.

- Select four links, including the link connected to the host computer, and set their link types to Frame Relay. See *Frame Relay Link Configuration, "Terminal Configuration Procedures, ► Set a link to Frame Relay."* Perform all steps as instructed for each link.

### ► Configure Link 1 as the network side

- See *Frame Relay Link Configuration, "Terminal Configuration Procedures, ► Set the Frame Relay port parameters."* Perform steps 1 to 5 of the procedure. Afterwards, perform the following steps:

1. In the Maintenance Protocol Mode screen, choose **1** (Network-side).

```

2) Maintenance protocol mode
-----
This field defines the mode of maintenance protocol running
over this port.
Current value ... [1  ]

Possible values:
0 - Perform user-side procedure on this port.
1 - Perform network-side procedure on this port.
2 - Perform NNI (Network to Network Interface) procedure
   on this port.

Enter one of the above values or <RETURN> to exit:

```

2. In the Frame Relay Port x Configuration menu, choose **13** (Internal Clock) to set the baud rate of the link.

```

FRAME RELAY port 1  configuration
-----
1) Maintenance protocol ..... [1  ]
2) Maintenance protocol mode ..... [1  ]
3) T391 (Link Integrity Verification Timer) .. [10 ]
4) T392 (Link Polling Verification Timer) .... [15 ]
5) N391 (Full Status Polling Cycle) ..... [6  ]
6) N392 (Error Threshold) ..... [3  ]
7) N393 (Monitored Events Count) ..... [4  ]
8) Rx pool red line (Frames)..... [4  ]
9) Rx pool OK (Frames)..... [6  ]
10) Tx pool red line (Frames)..... [40 ]
11) Tx pool OK (Frames)..... [30 ]
12) Tx ceiling (Frames)..... [50 ]
13) Internal Clock ..... [0  ]
14) HDLC options ..... [0  ]
15) Physical interface option ..... [0  ]
16) DLCI Header Mode ..... [0  ]

S) Save
CR) Exit

Select:

```



- In the Internal Clock menu, choose the option number according to your specifications.

```

13) Internal Clock
-----
Current value ... [0  ]
Possible values:
0 - External clock

Internal Clock
-----
1 - 2.4 Kbps      10 - 128 Kbps
2 - 4.8 Kbps      11 - 256 Kbps
3 - 9.6 Kbps      12 - 384 Kbps
4 - 14.4 Kbps     13 - 512 Kbps
5 - 19.2 Kbps     14 - 768 Kbps
6 - 38.4 Kbps     15 - 1008 Kbps
7 - 48 Kbps       16 - 1466 Kbps
8 - 56 Kbps       17 - 2016 Kbps
9 - 64 Kbps

Enter one of the above values or <RETURN> to exit:

```

- In the Frame Relay Port x Configuration menu, change other port parameters according to your network specifications or keep their default values. Choose **S** to save the configuration.

➤ **Configure Links 2, 3 and 4 as the user side**

- See *Frame Relay Link Configuration, "Terminal Configuration Procedures, ➤ Set the Frame Relay port parameters."* Perform steps 1 to 5 of the procedure for Link 2. Afterwards, perform the following steps:

- In the Maintenance Protocol Mode screen, choose **0** (User-side).

```

2) Maintenance protocol mode
-----
This field defines the mode of maintenance protocol running
over this port.
Current value ... [1  ]
Possible values:
0 - Perform user-side procedure on this port.
1 - Perform network-side procedure on this port.
2 - Perform NNI (Network to Network Interface) procedure
   on this port.

Enter one of the above values or <RETURN> to exit:

```

- In the Frame Relay Port x Configuration menu, change other port parameters according to your network specifications or keep their default values. Choose **S** to save the configuration.
- To set the Frame Relay port parameters for other links (links 3 and 4), repeat steps 1 to 7 of this procedure for each link.

➤ **Create and configure a source DLCI on Link 1**

1. Press ENTER several times so that the Configuration menu reappears. In the Configuration menu, choose **13** (Multicast).

```

Configuration menu
-----
1) Channel
2) Profile
3) Link
4) System parameters
5) PVC
6) Call ID
7) NUI
8) Alias
9) Routing table
10) Funnel
11) X.32
12) Management
13) Multicast
14) IP configuration
15) ISDN configuration
16) SNA
CR) Exit

Select:

```

Type a number for the new Multicast Group (**1** to **10**).

2. In the Multicast Group x Configuration menu, choose **M** (Multicast Group Source).

```

Multicast Group 1 configuration
-----
M) Multicast group source ..... [  ]
R) Retries Timer ..... [ 5 ]

          Members                      Members
          -----                      -----
1) [          ]                      14) [          ]
2) [          ]                      15) [          ]
3) [          ]                      16) [          ]
4) [          ]                      17) [          ]
5) [          ]                      18) [          ]
6) [          ]                      19) [          ]
7) [          ]                      20) [          ]
8) [          ]                      21) [          ]
9) [          ]                      22) [          ]
10) [         ]                      23) [          ]
11) [         ]                      24) [          ]
12) [         ]                      25) [          ]
13) [         ]                      CR) Exit

S) Save
Select:

```

- In the Multicast Source screen, type the number of the link connecting to the host computer (Link 1), a colon, and an unused DLCI number running on that link (DLCI 100). In this case, this value is **1:100**.

```

M) Multicast Source
-----

Current value ... [      ]

Possible values:
For X.25 Multicast      : Any valid X.25 source address
For Frame Relay Multicast: PORT:DLCI
For deleting the entry  : <SPACE>

Enter one of the above values or <RETURN> to exit:

```

The device creates the new DLCI.

### ► Create and configure a broadcast DLCI on Link 2

- In the Multicast Group x Configuration menu, choose **1** to define the first member of the Multicast Group.

```

Multicast Group 1 configuration
-----
M) Multicast group source ..... [      ]
R) Retries Timer ..... [ 5 ]

          Members
          -----
1) [      ]
2) [      ]
3) [      ]
4) [      ]
5) [      ]
6) [      ]
7) [      ]
8) [      ]
9) [      ]
10) [      ]
11) [      ]
12) [      ]
13) [      ]
14) [      ]
15) [      ]
16) [      ]
17) [      ]
18) [      ]
19) [      ]
20) [      ]
21) [      ]
22) [      ]
23) [      ]
24) [      ]
25) [      ]
CR) Exit

S) Save
Select:

```

- In the Destination DLCI screen, type the number of a link connecting to the Frame Relay network (Link 2), a colon, and an unused DLCI number running on that link (DLCI 110). In this case, this value is **2:110**.

```

1) Destination DLCI
-----

Current Value .....[      ]

Possible values:
          return   forward
          -----
For broadcast multicast -          PORT:DLCI          i.e : 2:200
For one way multicast  -  PORT:DLCI,PORT:DLCI        i.e : 1:100,2:200
For two way multicast  -          m,PORT:DLCI         i.e : m,2:200

For deleting the entry -          <SPACE>

Enter one of the above values or <RETURN> to exit:

```

The device creates the new DLCI.

➤ **Create and configure a one-way DLCI on Link 3**

1. In the Multicast Group x Configuration menu, choose **2** to define the next member of the Multicast Group.
2. In the Destination DLCI screen, type the number of the source link, a colon, and its DLCI (**1:100**). Then, type a comma followed by this member's link number and an unused DLCI number running on this link (**3:120**).

```

2) Destination DLCI
-----

Current Value .....[      ]

Possible values:
                return   forward
                -----   -----
For broadcast multicast -          PORT:DLCI          i.e : 2:200
For one way multicast  -  PORT:DLCI,PORT:DLCI        i.e : 1:100,2:200
For two way multicast  -          m,PORT:DLCI         i.e : m,2:200

For deleting the entry -      <SPACE>

Enter one of the above values or <RETURN> to exit:

```

The device creates the new DLCI.

➤ **Create and configure a two-way DLCI on Link 4**

1. In the Multicast Group x Configuration menu, choose **3** to define the next member of the Multicast Group.
2. In the Destination DLCI screen, type **m**, and a comma followed by this member's link number and an unused DLCI number running on this link (**4:130**).

```

2) Destination DLCI
-----

Current Value .....[      ]

Possible values:
                return   forward
                -----   -----
For broadcast multicast -          PORT:DLCI          i.e : 2:200
For one way multicast  -  PORT:DLCI,PORT:DLCI        i.e : 1:100,2:200
For two way multicast  -          m,PORT:DLCI         i.e : m,2:200

For deleting the entry -      <SPACE>

Enter one of the above values or <RETURN> to exit:

```

The device creates the new DLCI.

3. In the Multicast Group x Configuration menu, choose **S** to save the configuration.

## 2.18 HDLC Encapsulated Over Frame Relay

In this application, data passing through an HDLC link is switched through a Frame Relay link to a Frame Relay network.

This section describes configuration procedures for an HDLC to Frame Relay application. These procedures include:

- Set a link to Frame Relay
- Set a link to HDLC
- Set the Frame Relay port parameters
- Add and configure a DLCI
- Set the HDLC link parameters.

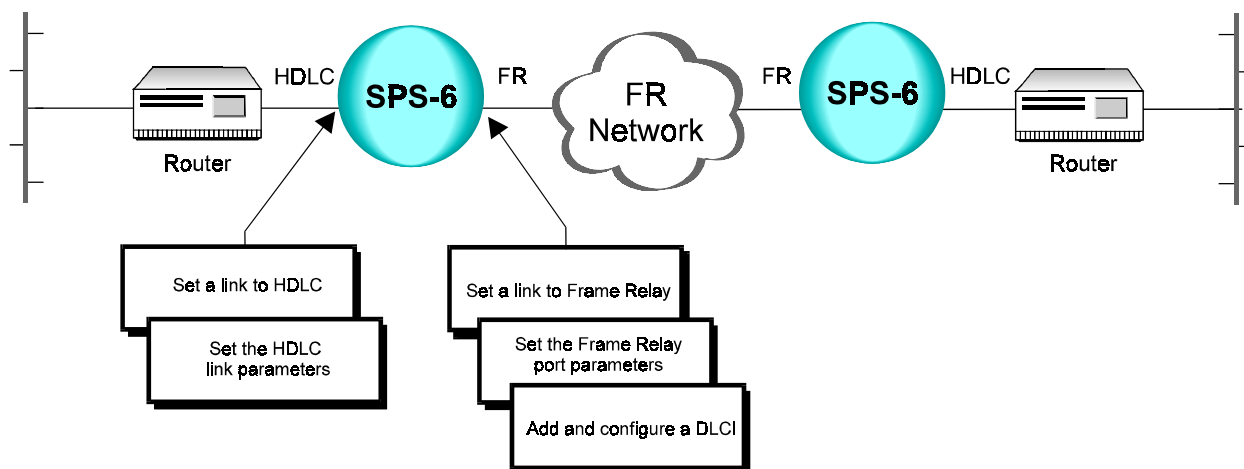

### Terminal Configuration Procedures



This section describes configuration procedures for an HDLC to Frame Relay application.

- **Set a link to Frame Relay**
  - See *Frame Relay Link Configuration, "Terminal Configuration Procedures, ➤ Set a link to Frame Relay."* Perform the steps as instructed.
- **Set a link to HDLC**
  - See *HDLC Link Configuration, "Terminal Configuration Procedures, ➤ Set a link to HDLC."* Perform the steps as instructed.

➤ **Set the Frame Relay port parameters**

- See *Frame Relay Link Configuration, "Terminal Configuration Procedures, ➤ Set the Frame Relay port parameters."* Perform steps 1 to 5 of the procedure. Afterwards, perform the following steps:

1. In the Maintenance Protocol Mode screen, choose **0** (User-side).

```

      2) Maintenance protocol mode
      -----
      This field defines the mode of maintenance protocol running
      over this port.
      Current value ... [1    ]

      Possible values:
      0 - Perform user-side procedure on this port.
      1 - Perform network-side procedure on this port.
      2 - Perform NNI (Network to Network Interface) procedure
          on this port.

      Enter one of the above values or <RETURN> to exit:
  
```

2. In the Frame Relay Port x Configuration menu, change other port parameters according to your network specifications or keep their default values. Choose **S** to save the configuration.

➤ **Add and configure a DLCI**

- See *Frame Relay Link Configuration, "Terminal Configuration Procedures, ➤ Add and configure a DLCI."* Perform steps 1 to 3 of the procedure. Afterwards, perform the following steps:

1. In the Encapsulation Type screen, choose **3** (Transparent HDLC Encapsulation).

```

      1) Encapsulation Type
      -----
      Current value ... [2    ]

      Possible values:
      1 - X25 encapsulation.
      2 - No protocol encapsulation.
      3 - Transparent HDLC encapsulation.
      4 - Asynchronous encapsulation.
      5 - Multi Point Encapsulation.
      6 - RFC1490 encapsulation.
      7 - Multicast

      Enter one of the above values or <RETURN> to exit:
  
```

2. Change other DLCI parameters according to your network specifications or keep their default values. Choose **S** to save the configuration.

► **Set the HDLC link parameters**

1. Press **ENTER** several times so that the Link Configuration menu reappears. In the Link Configuration menu, choose **3** (Update Link Parameters).

```

Link configuration
-----
1) Set Link type.
2) Display Links protocols.
3) Update Link parameters.
4) Display Links parameters.
CR) Exit

Select:

```

2. Choose the number of the HDLC link that you want to update.

```

Link | 1 | 2 | 3 | 4 | 5 | 6 |
-----|-----|-----|-----|-----|-----|-----|
Prot | FR | HDLC | X.25 | X.25 | X.25 | X.25 |

Enter Link number to update:

```

3. In the HDLC Link x Configuration menu, choose **9** (Destination Port).

```

HDLC link 2 configuration
-----
X25 Parameters:
1) Destination address ..... [0 ]
2) Destination subaddr ..... [1 ]
3) Redial time-out ..... [2 ] 6) X25 facilities ..... [0 ]
4) Redial retries ..... [5 ] 7) Local subaddress1 ... [1 ]
5) Inactivity ..... [0 ] 8) Local subaddress2 ... [1 ]

FR Parameters:
9) Destination port ..... [0 ]
10) Destination DLCI ..... [0 ]

General Parameters:
11) Protocol ..... [1 ] 14) Internal Clock ..... [0 ]
12) Flow control options ... [0 ] 15) NRZ mode ..... [0 ]
13) Buffer flow control ..... [10 ]

S) Save
CR) Exit

Select:

```

4. In the Destination Port screen, type the number of the Frame Relay link.

```

9) Destination port
-----
Current value ... [0 ]

Possible values:
Any valid link number.

Enter one of the above values or <RETURN> to exit:

```

5. In the HDLC Link x Configuration menu, choose **10** (Destination DLCI). In the Destination DLCI screen, type the number of the DLCI that you added in the procedure, "**► Add and configure a DLCI,**" earlier in this section.

```

10) Destination DLCI
-----
Current value ... [0  ]

Possible values:
Any valid DLCI number.

► Enter one of the above values or <RETURN> to exit:

```

6. In the HDLC Link x Configuration menu, choose **11** (Protocol). In the Protocol menu, choose **2** (Encapsulation over FR).

```

11) Protocol
-----
Current value ... [1  ]

Possible values:
0 - Inner HDLC switching.
1 - Encapsulation over X.25.
2 - Encapsulation over FR.
3 - Encapsulation over MPE.
4 - Destination IP.

► Enter one of the above values or <RETURN> to exit:

```

7. In the HDLC Link x Configuration menu, choose **12** (Flow Control Options). In the Flow Control Options screen, add the values of the parameters that match your specifications (for more information, see the *RAD Packet Switching Guide*).

```

12) Flow control options
-----
Current value ... [0  ]
This parameter specifies the type of flow
control of the HDLC link.
0 - No flow control
1 - CTS flow control
2 - Clock flow control
XXX - Any combination of the values specified above.

► Enter one of the above values or <RETURN> to exit:

```

For example, the value **3** (1 + 2) indicates that CTS flow control and Clock flow control are enabled.



8. If this packet switch is DCE, set the baud rate of the link. In the HDLC Link x Configuration menu, choose **14** (Internal Clock). In the Internal Clock menu, choose the option number according to your specifications.

```

14) Internal Clock
-----
Current value ... [0  ]
Possible values:
    0 - External clock

                Internal Clock
                -----
1 - 2.4 Kbps      10 - 128 Kbps
2 - 4.8 Kbps      11 - 256 Kbps
3 - 9.6 Kbps      12 - 384 Kbps
4 - 14.4 Kbps     13 - 512 Kbps
5 - 19.2 Kbps     14 - 768 Kbps
6 - 38.4 Kbps     15 - 1008 Kbps
7 - 48 Kbps       16 - 1466 Kbps
8 - 56 Kbps       17 - 2016 Kbps
9 - 64 Kbps

```

▶ Enter one of the above values or <RETURN> to exit:

9. Change other General Parameters according to your network's specifications or keep their default values. Choose **S** to save the configuration.

## RADview Configuration Procedures



This section describes RADview configuration procedures for an HDLC to Frame Relay application.

### ➤ Set a link to Frame Relay

- See *Frame Relay Link Configuration*, "RADview Configuration Procedures, ➤ Set a link to Frame Relay." Perform steps 1 to 3. Afterwards, perform the following step:

1. Click **Save**. Click **OK** to confirm.

### ➤ Set a link to HDLC

- See *HDLC Link Configuration*, "RADview Configuration Procedures, ➤ Set a link to HDLC." Perform the steps as instructed.

### ➤ Set the Frame Relay port parameters

1. In the PS View window, double-click the Frame Relay link. The FR window appears.

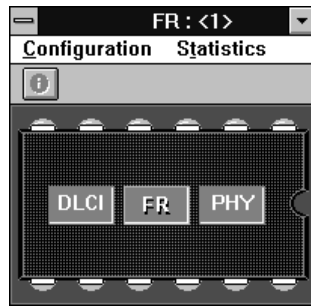

2. In the FR window, click **FR**. On the FR **Configuration** menu, point to **Parameters** and click **Quick Config**. In the FR Quick Config dialog box, click **Scratch** to switch to the Scratch configuration mode.

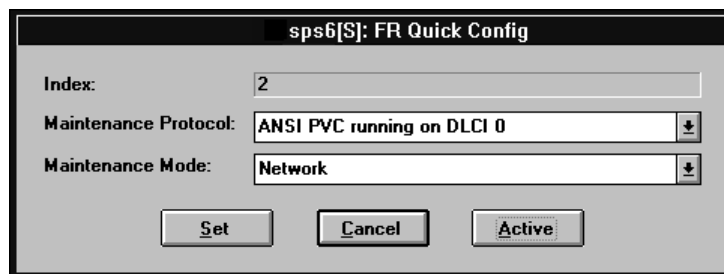

3. In the Maintenance Protocol list, click the same protocol as the Frame Relay network.
4. In the Maintenance Mode list, click **User**. Click **Set**.

**Note**

*If you want to change additional port parameters according to your specifications, open the FR **Configuration** menu, point to **Parameters** and click **Full Config** to open the Full Config dialog box.*

5. On the FR **Configuration** menu, click **Save**. Click **OK** to confirm.

➤ **Add and configure a DLCI**

1. In the FR window, click **DLCI**. On the DLCI **Configuration** menu, click **Parameters**.

Index:	0
Destination Protocol	None
Destination Id	0:0
Backup Id:	0:0
Tx CIR Interval (0.1 sec)	10
Tx Committed (byte/interval)	3200
Tx Excess (byte/interval)	6400
Rx CIR Interval (0.1 sec)	10
Rx Committed (byte/interval)	3200
Rx Excess (byte/interval)	6400
Funnel Id	0

2. In the DLCI Parameters table, click **Scratch** to switch to the Scratch configuration mode and then click **Add**.

3. The Add DLCI Parameters dialog box appears. In the Destination Protocol list, click **HDLC**.
4. Change other DLCI parameters according to your network specifications or keep their default values. Click **Set**.
5. In the DLCI Parameters table, click the new DLCI, click **Save** and then click **Entry**.  
To save the complete DLCI table, click **Save** and then click **All**.
6. Close the Link 1 FR window.

➤ **Set the HDLC link parameters**

1. In the PS View window, double-click the HDLC link. The HDLC window appears.

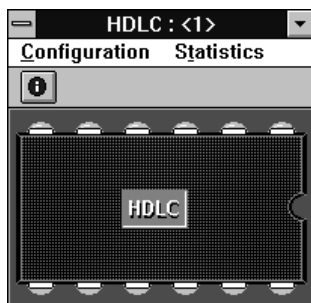

2. In the HDLC window, click **HDLC**. On the HDLC **Configuration** menu, click **Parameters**. In the HDLC Parameters dialog box, click **Scratch** to switch to the Scratch configuration mode.

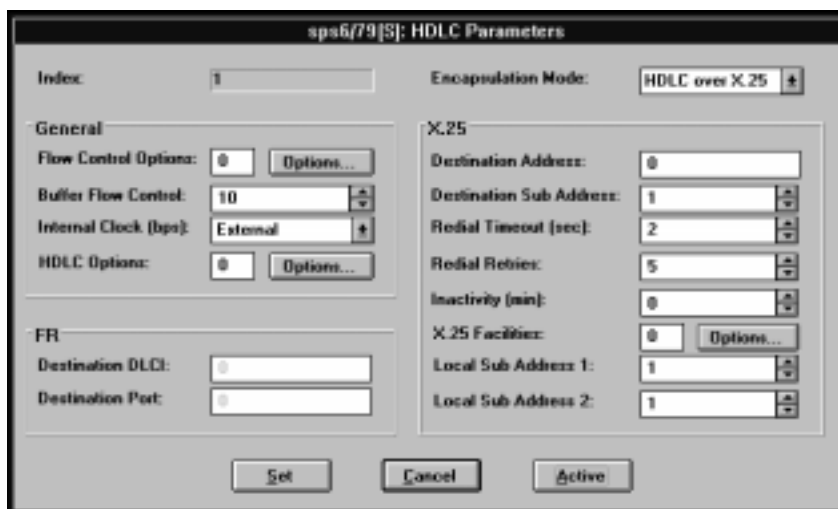

3. In the HDLC Parameters dialog box, set the following parameters:
  - Encapsulation Mode - **HDLC over FR**
  - Destination Port - the Frame Relay link number
  - Destination DLCI - the DLCI added in the procedure, “➤ *Add and configure a DLCI*,” earlier in this section.
  - Flow Control Options - sum of the values of the parameters that match your specifications (for more information, see the *RADview-PC Packet Switching Application User's Manual*). For example, the value **3** (1 + 2) indicates that CTS flow control and Clock flow control are enabled.
  - Internal Clock - the baud rate according to your specifications.
4. Change other General Parameters according to your network's specifications or keep their default values. Click **Set**.
5. In the HDLC window, open the **Configuration** menu and click **Save**. Click **OK** to confirm.

## 2.19 HDLC Encapsulated Over X.25

In this application, data passing through an HDLC link is switched through an X.25 link to an X.25 network.

This section describes configuration procedures for an HDLC to X.25 application. These procedures include:

- Select an X.25 link that connects to the X.25 network
- Set the X.25 link parameters
- Set a link to HDLC
- Set the HDLC link parameters
- Add a routing table entry.

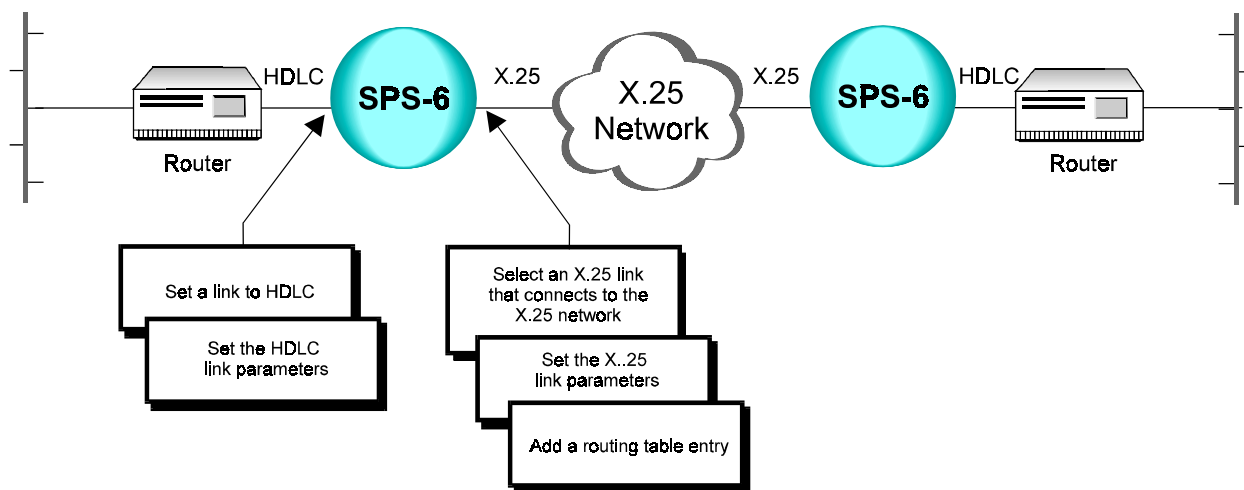

### Terminal Configuration Procedures



This section describes configuration procedures for an HDLC to X.25 application.

- **Select an X.25 link that connects to the X.25 network**
  - See *X.25 Link Configuration, "Terminal Configuration Procedures, ➤ Select an X.25 link."* Perform the steps as instructed.
- **Set the X.25 link parameters**
  - See *X.25 Link Configuration, "Terminal Configuration Procedures, ➤ Set X.25 link parameters."* Perform the steps as instructed.
- **Set a link to HDLC**
  - See *HDLC Link Configuration, "Terminal Configuration Procedures, ➤ Set a link to HDLC."* Perform the steps as instructed.

➤ **Set the HDLC link parameters**

1. Press ENTER several times so that the Link Configuration menu reappears. In the Link Configuration menu, choose **3** (Update Link Parameters).

```

Link configuration
-----
1) Set Link type.
2) Display Links protocols.
3) Update Link parameters.
4) Display Links parameters.
CR) Exit

Select:

```

2. Choose the number of the HDLC link that you want to update.

```

Link | 1 | 2 | 3 | 4 | 5 | 6 |
-----|---|---|---|---|---|---|
Prot | X.25 | HDLC | X.25 | X.25 | X.25 | X.25 |

Enter Link number to set:

```

3. In the HDLC Link x Configuration menu, choose **1** (Destination Address).

```

HDLC link 2 configuration
-----

X25 Parameters:
1) Destination address ..... [0 ]
2) Destination subaddr ..... [1 ]
3) Redial time-out ..... [2 ] 6) X25 facilities ..... [0 ]
4) Redial retries ..... [5 ] 7) Local subaddress1 ... [1 ]
5) Inactivity ..... [0 ] 8) Local subaddress2 ... [1 ]

FR Parameters:
9) Destination port ..... [0 ]
10) Destination DLCI ..... [0 ]

General Parameters:
11) Protocol ..... [1 ] 14) Internal Clock ..... [0 ]
12) Flow control options ... [0 ] 15) NRZ mode ..... [0 ]
13) Buffer flow control ..... [10 ]

S) Save
CR) Exit

Select:

```

4. In the Destination Address screen, type the X.25 address of the destination packet switch.

```

1) Destination address
-----
Current value ... [0 ]

Possible values:
Up to 15 digits

Enter one of the above values or <RETURN> to exit:

```

5. In the HDLC Link x Configuration menu, choose **2** (Destination Subaddress). In the Destination Subaddress screen, type the local subaddress of the destination packet switch.

```

2) Destination subaddress
-----
Current value ... [1  ]

Possible values:
A two digit number

Enter one of the above values or <RETURN> to exit:

```

6. In the HDLC Link x Configuration menu, choose **5** (Inactivity). In the Inactivity screen, type the maximum number of minutes of inactivity before the session disconnects. For example, if Inactivity = 5, the line will disconnect automatically after 5 minutes if no data passes through it.

```

5) Inactivity
-----
Current value ... [0  ]

Possible values:
0 - No disconnection on inactivity
1..255 - Timer value (in minutes)

Enter one of the above values or <RETURN> to exit:

```

7. The default protocol (parameter 11) is **1** (Encapsulation over X.25). If the current value is different, choose **11** (Protocol). In the Protocol menu, choose **1** (Encapsulation over X.25).

```

11) Protocol
-----
Current value ... [1  ]

Possible values:
0 - Inner HDLC switching.
1 - Encapsulation over X.25.
2 - Encapsulation over FR.
3 - Encapsulation over MPE.
4 - Destination IP.

Enter one of the above values or <RETURN> to exit:

```

8. In the HDLC Link x Configuration menu, choose **12** (Flow Control Options). In the Flow Control Options screen, add the values of the parameters that match your specifications (for more information, see the *RAD Packet Switching Guide*).

```

12) Flow control options
-----
Current value ... [0  ]
This parameter specifies the type of flow
control of the HDLC link.
0 - No flow control
1 - CTS flow control
2 - Clock flow control
XXX - Any combination of the values specified above.

Enter one of the above values or <RETURN> to exit:

```

For example, the value **3** (1 + 2) indicates that CTS flow control and Clock flow control are enabled.

9. If this packet switch is DCE, set the baud rate of the link. In the HDLC Link x Configuration menu, choose **14** (Internal Clock). In the Internal Clock menu, choose the option number according to your specifications.

```

14) Internal Clock
-----
Current value ... [0  ]

Possible values:

0 - External clock

                Internal Clock
                -----
1 - 2.4 Kbps      10 - 128 Kbps
2 - 4.8 Kbps      11 - 256 Kbps
3 - 9.6 Kbps      12 - 384 Kbps
4 - 14.4 Kbps     13 - 512 Kbps
5 - 19.2 Kbps     14 - 768 Kbps
6 - 38.4 Kbps     15 - 1008 Kbps
7 - 48 Kbps       16 - 1466 Kbps
8 - 56 Kbps       17 - 2016 Kbps
9 - 64 Kbps

Enter one of the above values or <RETURN> to exit:

```

10. Change other General Parameters according to your network's specifications or keep their default values. Choose **S** to save the configuration.

➤ **Add a routing table entry**

In this application, the routing goes to link 1 (X.25 network and remote packet switch).

- See *X.25 Link Configuration, "Terminal Configuration Procedures, ➤ Add a routing table entry."* Perform steps 1 to 3 of the procedure. Afterwards, perform the following steps:

1. In the Destination Link screen, choose **1** as the valid X.25 link number.

```

1) Destination link

Current value ... [1  ]

Possible values:
L - local channel.
Any valid X.25 link number.
Any valid FRAME RELAY DLCI with an X.25 destination protocol,
the DLCI is presented in the form of {port:DLCI}
ISDN routing entry number preceded by the letter 'I' (i.e.: I5)

Enter one of the above values or <RETURN> to exit:

```



- In the Routing Table Entry x Configuration menu, choose **4** (Address). In the Address screen, type the X.25 address of the remote packet switch.

```

4) Address
-----
Current value ... [      ]

Possible values:
Up to 15 decimal digits or X (don't care) digits.

▶ Enter one of the above values or <RETURN> to exit:

```

- In the Routing Table Entry x Configuration menu, choose **S** to save the configuration.

## RADview Configuration Procedures



This section describes RADview configuration procedures for an HDLC to X.25 application.

➤ **Select an X.25 link that connects to the X.25 network**

- See *X.25 Link Configuration, "RADview Configuration Procedures, ➤ Select an X.25 link."* Perform the steps as instructed.

➤ **Set the X.25 link parameters**

- See *X.25 Link Configuration, "RADview Configuration Procedures, ➤ Set X.25 link parameters."* Perform the steps as instructed.

➤ **Set a link to HDLC**

- See *HDLC Link Configuration, "RADview Configuration Procedures, ➤ Set a link to HDLC."* Perform the steps as instructed.

➤ **Set the HDLC link parameters**

- In the PS View window, double-click the HDLC link. The HDLC window appears.

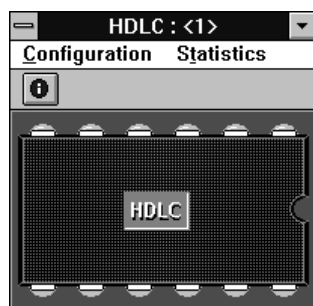

- In the HDLC window, click **HDLC**. On the HDLC **Configuration** menu, click **Parameters**. In the HDLC Parameters dialog box, click **Scratch** to switch to the Scratch configuration mode.

- In the HDLC Parameters dialog box, set the following parameters:
  - Encapsulation Mode - **HDLC over X.25**
  - Destination Address - X.25 address of the remote packet switch
  - Destination Subaddress - Local subaddress on the remote packet switch
  - Inactivity - Number of minutes of inactivity after which the session disconnects. For example, if Inactivity = 5, the line will disconnect automatically after 5 minutes if no data passes through it.
  - Flow Control Options - sum of the values of the parameters that match your specifications (for more information, see the *RADview-PC Packet Switching Application User's Manual*). For example, the value **3** (1 + 2) indicates that CTS flow control and Clock flow control are enabled.
  - Internal Clock - the baud rate according to your specifications.
- Change other General Parameters according to your network's specifications or keep their default values. Click **Set**.
- In the HDLC window, open the **Configuration** menu and click **Save**. Click **OK** to confirm.

➤ **Add a routing table entry**

In this application, the routing goes to link 1 (X.25 network and destination packet switch).

- See *X.25 Link Configuration, "RADview Configuration Procedures, ➤ Add a routing table entry."* Perform steps 1 and 2 of the procedure. Afterwards, perform the following steps:

1. The Add Routing Table dialog box appears. In the Address box, type the address of the remote packet switch.

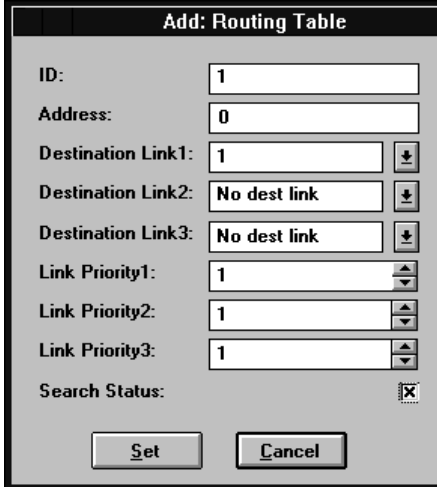

The screenshot shows a dialog box titled "Add: Routing Table". It contains the following fields and controls:

- ID:** A text box containing the value "1".
- Address:** A text box containing the value "0".
- Destination Link1:** A dropdown menu with "1" selected.
- Destination Link2:** A dropdown menu with "No dest link" selected.
- Destination Link3:** A dropdown menu with "No dest link" selected.
- Link Priority1:** A spin box with "1" selected.
- Link Priority2:** A spin box with "1" selected.
- Link Priority3:** A spin box with "1" selected.
- Search Status:** A checkbox that is checked.
- At the bottom, there are two buttons: "Set" and "Cancel".

2. In the Destination Link 1 list, click link number **1**.
3. In the Link Priority 1 list, click the number of calls to be routed through this link before calls are routed to backup links. Click **Set**.
4. In the Routing Table, click **Refresh** to display the new routing configuration.



## Terminal Configuration Procedures



The following steps describe configuration procedures for an HDLC to HDLC Rate Converter application.

### ► Set two links to HDLC

In this application, link 1 connects to a time division multiplexer (TDM) and Link 3 connects to a modem providing access to an external network.

#### Note

Verify that both HDLC links are DTE.

- Select two links and set their link types to HDLC. See *HDLC Link Configuration, "Terminal Configuration Procedures, ► Set a link to HDLC."* Perform the steps as instructed.

### ► Set the HDLC link 1 parameters

1. Press ENTER several times so that the Link Configuration menu reappears. In the Link Configuration menu, choose **3** (Update Link Parameters).

```

Link configuration
-----
1) Set Link type.
2) Display Links protocols.
3) Update Link parameters.
4) Display Links parameters.
CR) Exit

Select:

```

2. Choose the number of the HDLC link that connects to the TDM (Link 1).

Link	1	2	3	4	5	6
Prot	HDLC	X.25	HDLC	X.25	X.25	X.25

Enter Link number to set:

3. In the HDLC Link x Configuration menu, choose **2** (Destination Subaddress).

```

HDLC link 1 configuration
-----

X25 Parameters:
1) Destination address ..... [0 ]
2) Destination subaddr ..... [1 ]
3) Redial time-out ..... [2 ] 6) X25 facilities ..... [0 ]
4) Redial retries ..... [5 ] 7) Local subaddress1 ... [1 ]
5) Inactivity ..... [0 ] 8) Local subaddress2 ... [1 ]

FR Parameters:
9) Destination port ..... [0 ]
10) Destination DLCI ..... [0 ]

General Parameters:
11) Protocol ..... [1 ] 14) Internal Clock ..... [0 ]
12) Flow control options ... [0 ] 15) NRZ mode ..... [0 ]
13) Buffer flow control ..... [10 ]

S) Save
CR) Exit

Select:

```

4. In the Destination Subaddress screen, type the local subaddress of the link connecting to the modem (Link 3).

```

      2) Destination subaddress
      -----
Current value ... [1  ]

Possible values:
A two digit number

▶ Enter one of the above values or <RETURN> to exit:

```

5. In the HDLC Link x Configuration menu, choose **7** (Local Subaddress 1). In the Local Subaddress 1 screen, type the local subaddress of the selected link (Link 1).

```

      7) Local subaddress1
      -----
Current value ... [1  ]

Possible values:
A two digit number

▶ Enter one of the above values or <RETURN> to exit:

```

6. In the HDLC Link x Configuration menu, choose **11** (Protocol). In the Protocol menu, choose **0** (Inner HDLC Switching).

```

     11) Protocol
     -----
Current value ... [1  ]

Possible values:
0 - Inner HDLC switching.
1 - Encapsulation over X.25.
2 - Encapsulation over FR.
3 - Encapsulation over MPE.
4 - Destination IP.

▶ Enter one of the above values or <RETURN> to exit:

```

7. In the HDLC Link x Configuration menu, choose **12** (Flow Control Options). In the Flow Control Options screen, choose **1** (CTS flow control).

```

     12) Flow control options
     -----
Current value ... [0  ]
This parameter specifies the type of flow
control of the HDLC link.
0 - No flow control
1 - CTS flow control
2 - Clock flow control
XXX - Any combination of the values specified above.

▶ Enter one of the above values or <RETURN> to exit:

```

8. Change other HDLC General Parameters according to your network's specifications or keep their default values. Choose **S** to save the configuration.

➤ **Set the HDLC link 3 parameters**

1. Press ENTER several times so that the Link Configuration menu reappears. In the Link Configuration menu, choose **3** (Update Link Parameters).

```

Link configuration
-----
1) Set Link type.
2) Display Links protocols.
3) Update Link parameters.
4) Display Links parameters.
CR) Exit

Select:

```

2. Choose the number of the HDLC link that connects to the modem (Link 3).

```

Link | 1 | 2 | 3 | 4 | 5 | 6 |
-----|-----|-----|-----|-----|-----|
Prot | HDLC | X.25 | HDLC | X.25 | X.25 | X.25 |

Enter Link number to set:

```

3. In the HDLC Link x Configuration menu, choose **2** (Destination Subaddress).

```

HDLC link 3 configuration
-----
X25 Parameters:
1) Destination address ..... [0 ]
2) Destination subaddr ..... [1 ]
3) Redial time-out ..... [2 ]
4) Redial retries ..... [5 ]
5) Inactivity ..... [0 ]
6) X25 facilities ..... [0 ]
7) Local subaddress1 ... [1 ]
8) Local subaddress2 ... [1 ]

FR Parameters:
9) Destination port ..... [0 ]
10) Destination DLCI ..... [0 ]

General Parameters:
11) Protocol ..... [1 ]
12) Flow control options ... [0 ]
13) Buffer flow control ..... [10 ]
14) Internal Clock ..... [0 ]
15) NRZ mode ..... [0 ]

S) Save
CR) Exit

Select:

```

4. In the Destination Subaddress screen, type the local subaddress of the link connecting to the TDM (Link 1).

```

2) Destination subaddress
-----
Current value ... [1 ]

Possible values:
A two digit number

Enter one of the above values or <RETURN> to exit:

```

5. In the HDLC Link x Configuration menu, choose **7** (Local Subaddress 1). In the Local Subaddress 1 screen, type the local subaddress of the selected link (Link **3**).

```

    7) Local subaddress1
    -----
    Current value ... [1  ]

    Possible values:
    A two digit number

    Enter one of the above values or <RETURN> to exit:
  
```

6. In the HDLC Link x Configuration menu, choose **11** (Protocol). In the Protocol menu, choose **0** (Inner HDLC Switching).

```

    11) Protocol
    -----
    Current value ... [1  ]

    Possible values:
    0 - Inner HDLC switching.
    1 - Encapsulation over X.25.
    2 - Encapsulation over FR.
    3 - Encapsulation over MPE.
    4 - Destination IP.

    Enter one of the above values or <RETURN> to exit:
  
```

7. In the HDLC Link x Configuration menu, choose **12** (Flow Control Options). In the Flow Control Options screen, choose **1** (CTS flow control).

```

    12) Flow control options
    -----
    Current value ... [0  ]
    This parameter specifies the type of flow
    control of the HDLC link.
    0 - No flow control
    1 - CTS flow control
    2 - Clock flow control
    XXX - Any combination of the values specified above.

    Enter one of the above values or <RETURN> to exit:
  
```

8. Change other HDLC General Parameters according to your network's specifications or keep their default values. Choose **S** to save the configuration.



## RADview Configuration Procedures



The following steps describe RADview configuration procedures for an HDLC to HDLC Rate Converter application.

### ➤ Set two links to HDLC

In this application, link 1 connects to a time division multiplexer (TDM) and Link 3 connects to a modem providing access to an external network.

#### Note

Verify that both HDLC links are DTE.

- See *HDLC Link Configuration*, “RADview Configuration Procedures, ➤ Set a link to HDLC.” Perform steps 1 to 3 for one of the desired links. Afterwards, perform the following steps:

1. Click **Save**. Click **OK** to confirm.
2. For the second HDLC link, repeat steps 1 to 4 of this procedure.
3. Perform reset to implement the protocol type change.

### ➤ Set the HDLC link 1 parameters

1. In the PS View window, double-click the HDLC link that connects to the TDM (Link 1). The HDLC window appears.



2. In the HDLC window, click **HDLC**. On the HDLC **Configuration** menu, click **Parameters**. In the HDLC Parameters dialog box, click **Scratch** to switch to the Scratch configuration mode.

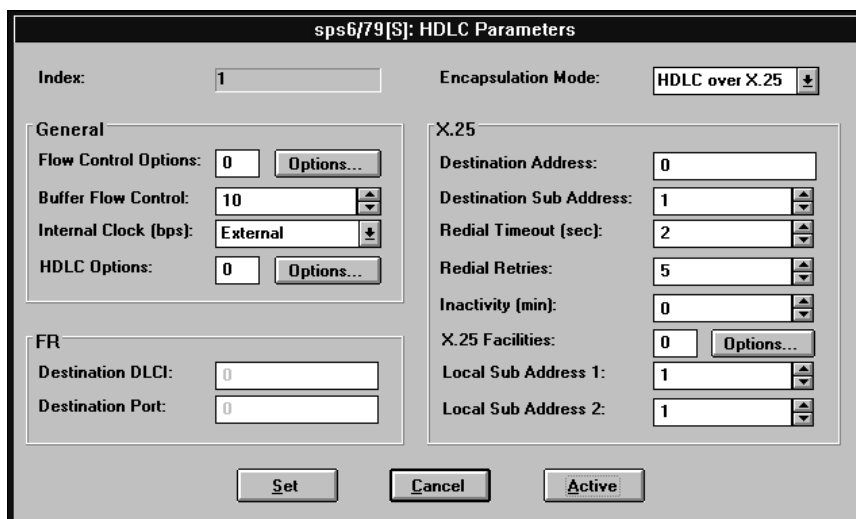

3. In the HDLC Parameters dialog box, set the following parameters:
    - Encapsulation Mode - **HDLC to HDLC**
    - Destination Subaddress - Local subaddress of the link connecting to the modem (Link **3**).
    - Local Subaddress 1 - Local subaddress of the selected link (Link **1**).
    - Flow Control Options - **1** (CTS Flow Control)
  4. Change other HDLC General Parameters according to your network's specifications or keep their default values. Click **Set**.
  5. In the HDLC window, open the **Configuration** menu and click **Save**. Click **OK** to confirm.
- **Set the HDLC link 3 parameters**
1. In the PS View window, double-click the HDLC link that connects to the modem (Link 3).
  2. In the HDLC window, click **HDLC**. On the HDLC **Configuration** menu, click **Parameters**. In the HDLC Parameters dialog box, click **Scratch** to switch to the Scratch configuration mode.
  3. In the HDLC Parameters dialog box, set the following parameters:
    - Encapsulation Mode - **HDLC to HDLC**
    - Destination Subaddress - Local subaddress of the link connecting to the TDM (Link **1**).
    - Local Subaddress 1 - Local subaddress of the selected link (Link **3**).
    - Flow Control Options - **1** (CTS Flow Control)
  4. Change other HDLC General Parameters according to your network's specifications or keep their default values. Click **Set**.
  5. In the HDLC window, open the **Configuration** menu and click **Save**. Click **OK** to confirm.

---

---

## 2.21 LAN Ethernet Application (Routing)

Connecting an Ethernet LAN through packet switches and routing LAN IP packets over X.25 and Frame Relay networks.

This section describes configuration procedures of a packet switch in a LAN Ethernet routing application. These procedures include:

- Set a link to Ethernet (Subnet 1)
- Set the Ethernet link parameters
- Add IP Interfaces
- Select an X.25 link that connects to an X.25 network (Subnet 3)
- Set the X.25 link parameters
- Set a link to Frame Relay (Subnet 2)
- Set the Frame Relay link parameters
- Add an IP Routing table entry for the link to Subnet 2
- Add an IP Routing table entry for the link to the ISP
- Add an IP Routing table entry for the link to Subnet 3

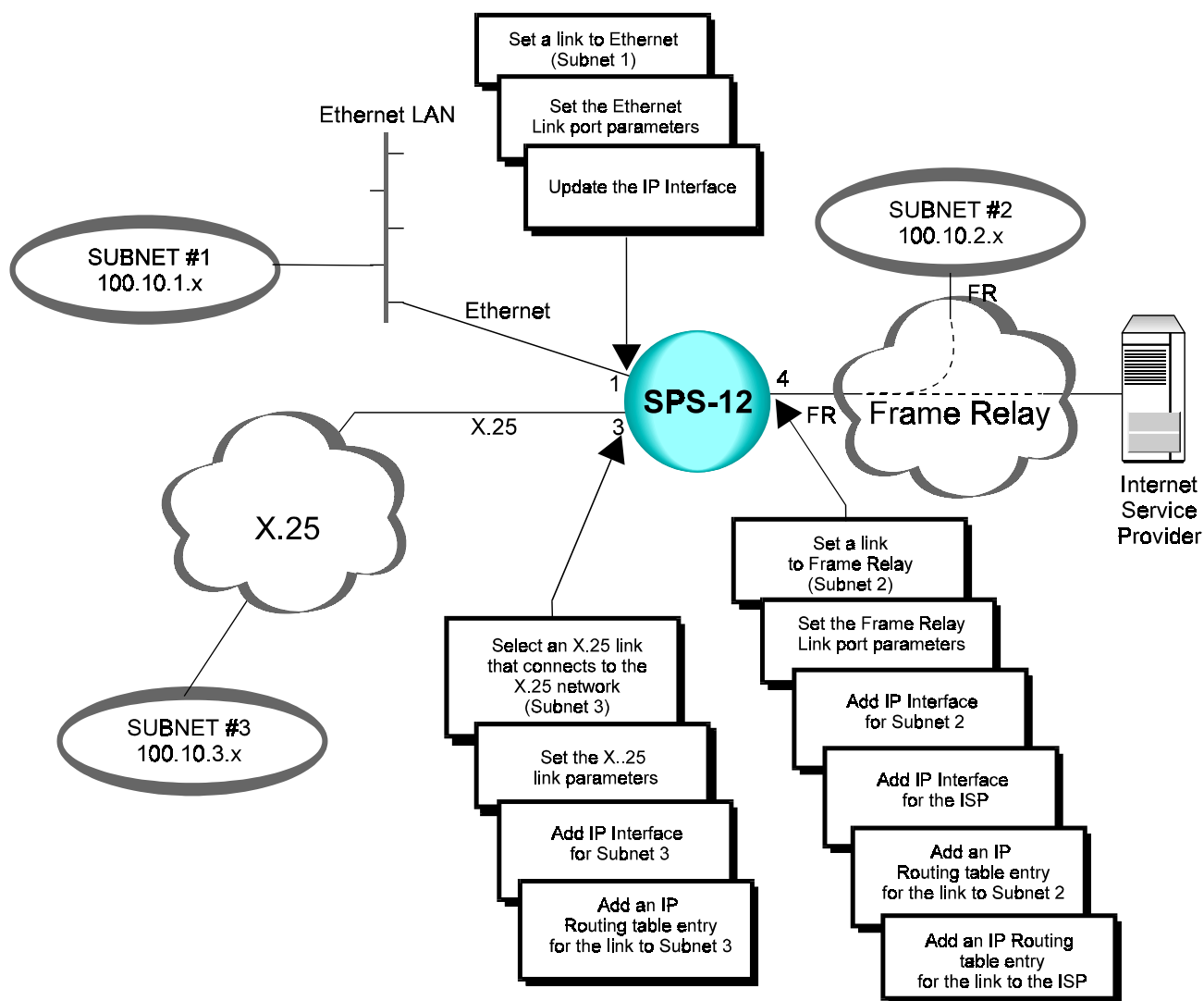

**Note** *The specific IP addresses and masks in this section are hypothetical and do not reflect an actual configuration. For your application, substitute the appropriate IP addresses and masks in place of those specified in this section.*

## Terminal Configuration Procedures



### Note

The following section describes configuration procedures of a packet switching device in a LAN Ethernet (Routing) application.

---

*This application requires prior installation of a IR-ETH interface card in the following synchronous links, depending on the packet switch models used in your application:*

*For SPS-12 - link no. 1 or 7.*

*For SPS-3S, SPS-6 - link no. 1.*

*For APS devices - any link.*

*For FPS-8 - link no. 9 or 10.*

*Any external Tiny Bridge can also be used in any other link.*

---

### ► Set a link to Ethernet (Subnet 1)

In this application, link 1 is connected to an Ethernet LAN (subnet 1).

1. In the Configuration menu, choose **3** (Link).

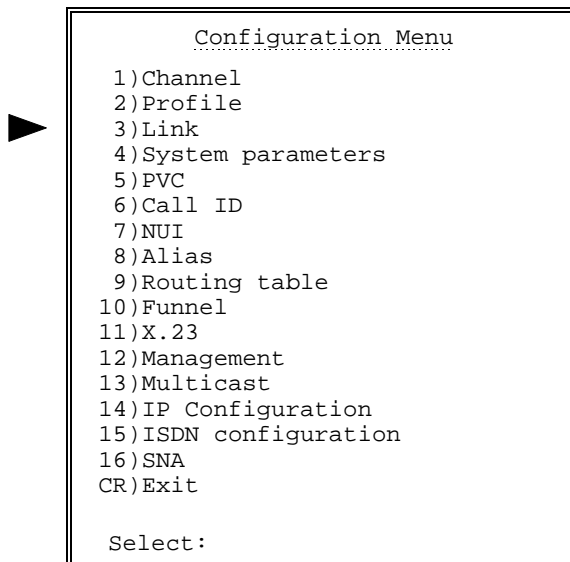

- In the Link Configuration menu, choose **1** (Set Link Type).

```

Link configuration
1)Set Link type.
2)Display Links protocols.
3)Update Link parameters.
4)Display Links parameters.
CR)Exit

Select:

```

- Choose the number of the link that you want to set to Ethernet (Link **1**).

```

Link | 1 | 2 | 3 | 4 | 5 | 6 |
-----|-----|-----|-----|-----|-----|-----|
Prot | X.25 | x.25 | X.25 | x.25 | x.25 | x.25 |
Enter Link number to SET:

```

- In the Link Types menu, choose **13** (Ethernet).

```

LINK TYPES
1)X.25
2)FRAME RELAY
3)HDLC
4)SDLC
5)ASYNC
6)STM4/4HS
7)STM8/8HS
8)STM16/16HS
9)STM24/24HS
10)MPE (Multi Point Encapsulator)
11)BISYNC HPAD
12)BYSYNC TPAD
13)ETHERNET
CR)Exit

Select:

```

- A warning appears stating that this action will set this Ethernet link's parameters to their default values. Choose **Y** to continue.

➤ **Set the Ethernet link parameters**

- Press **ENTER** several times so that the Link Configuration menu reappears. In the Link Configuration menu, choose **3** (Update Link Parameters).
- Choose the number of the Ethernet link that you want to update (Link **1**).

```

Link | 1 | 2 | 3 | 4 | 5 | 6 | 7 | 8 | 9 | 10 | 11 | 12 |
-----|-----|-----|-----|-----|-----|-----|-----|-----|-----|-----|-----|
Prot | ETHER | x.25 | X.25 | FR | x.25 | x.25 | X.25 | x.25 | X.25 | x.25 | x.25 | x.25 |
Enter Link number to UPDATE:

```

3. In the Ethernet Link x Configuration menu, choose **1** (Operation Mode).

```

Ethernet Link 1 configuration
-----
1) Operation mode.
2) Interface configuration.
3) Bridging configuration.
CR) Exit

Select:

```

4. In the Operation Mode menu, choose **1** (IP handling).

```

Operation Mode
-----
1) IP handling ..... [ 1 ]
2) LLC handling ..... [ 0 ]
3) Bridging handling ..... [ 0 ]
S) Save.
CR) Exit

Select:

```

5. In the IP handling menu, choose **1** (Enable - default.)

```

1) IP handling
-----
Current value ... [ 1 ]

Possible values:
0 - Disable
1 - Enable

Enter one of the above values or <RETURN> to exit:

```

6. In the Operation Mode menu, choose **S** to save the configuration.

7. In the Ethernet Link x Configuration menu, choose **2** (Interface configuration).

```

Ethernet Link 1 configuration
-----
1) Operation mode.
2) Interface configuration.
3) Bridging configuration.
CR) Exit

Select:

```

8. In the Interface configuration menu, choose **1** (MAC address).

```

Interface configuration
-----
1) MAC Address ..... [0000 0000 0000]
2) BandWidth ..... [ 0 ]
S) Save.
CR) Exit

Select:

```

9. In the I MAC address menu, enter the required MAC address.

```

1) MAC Address
-----

Current value ... [0000 0000 0000]

Possible values:
  3 sets of 4 Hexadecimal digits with
  spaces between them (XXXX XXXX XXXX)

Enter one of the above values or <RETURN> to exit:

```

10. In the Interface configuration menu, choose **S** to save the configuration.

11. In the Configuration menu, choose **14** (IP Configuration).

```

Configuration Menu
-----

1)Channel
2)Profile
3)Link
4)System parameters
5)PVC
6)Call ID
7)NUI
8)Alias
9)Routing table
10)Funnel
11)X.23
12)Management
13)Multicast
14)IP Configuration
15)ISDN configuration
16)SNA
CR)Exit

Select:

```

12. In the IP Configuration menu, choose **2** (IP Interface).

```

IP Configuration
-----

1) IP global parameters.
2) IP interface.
3) IP static route.
CR) Exit

Select:

```

13. In the IP Interface Configuration menu, choose **4** (Display IP Interface Entry). The system generates the IP interface for the Ethernet connection automatically.

```

IP Interface Configuration
-----

1) Add IP Interface Entry.
2) Delete IP Interface Entry.
3) Update IP Interface Entry.
4) Display IP Interface Entry.
CR) Exit.

Select:

```

Make a note of the IP interface entry for the Ethernet destination and press ENTER.



14. In the IP Interface Configuration menu, choose **3** (Update IP Interface Entry).

```

IP Interface Configuration
-----
1) Add IP Interface Entry.
2) Delete IP Interface Entry.
3) Update IP Interface Entry.
4) Display IP Interface Entry.
CR) Exit.

Select:

```

Type the IP Interface you made note of in the previous step.

15. In the IP Interface x Configuration menu, choose **1** (IP address).

```

IP Interface 1 Configuration
-----
1) IP address ..... [0.0.0.0]
2) IP mask ..... [255.255.255.255]
3) RIP mode ..... [ 0 ]
4) Destination ..... [No Destination]
5) Default route metric ..... [Disabled]
6) Inactivity timer ..... [ ]
7) Link cost ..... [ 1 ]
8) Options ..... [ 0 ]
S) Save.
CR) Exit.

Select:

```

16. In the IP Address screen, type the IP address of subnet 1 (e.g. 100.10.1.1).

```

1) IP address
-----
Current value ... [0.0.0.0]

Possible values:
A string of the format: X.X.X.X
Where every X is a number in the range 0 - 255.

Enter one of the above values or <RETURN> to exit:

```

17. In the IP Interface x Configuration menu, choose **2** (IP mask).

18. In the IP mask menu, type 255.255.255.0.

```

2) IP mask
-----
Current value ... [255.255.255.255]

Possible values:
A string of the format: X.X.X.X
Where every X is a number in the range 0 - 255.

Enter one of the above values or <RETURN> to exit: 255.255.255.240

```

Choose **S** to save the configuration.

➤ **Select an X.25 link that connects to an X.25 network (Subnet 3)**

In this application, link 3 is connected to subnet 3 through an X.25 network.

- See Section 3.2, "Terminal Configuration Procedures, ➤ Select an X.25 link." Perform all steps as instructed.

➤ **Set the X.25 link parameters**

- See Section 3.2, “Terminal Configuration Procedures, ➤ Set the Link 1 parameters.” Perform all steps as instructed.

➤ **Set a link to Frame Relay (Subnet 2)**

In this application, link 4 is connected to an Internet Service Provider (ISP) and to Subnet 2 over a Frame Relay network.

- See Section 3.3, “Terminal Configuration Procedures, ➤ Set a link to Frame Relay.” Perform all steps as instructed.

➤ **Set the Frame Relay link parameters**

- See Section 3.3, “Terminal Configuration Procedures, ➤ Set the Frame Relay port parameters.” Perform steps 1 to 5 of the procedure. Afterwards, perform the following steps:

1. In the Maintenance Protocol Mode screen, choose **0** (User-side).

```

2) Maintenance protocol mode
-----
This field defines the mode of maintenance protocol running over this
port.
Current value [1      ]

Possible values:
0 - Perform user-side procedure on this port.
1 - Perform network-side procedure on this port.
2 - Perform NNI (Network to Network Interface) procedure on this port.

Enter one of the above values or <RETURN> to exit:

```

2. In the Frame Relay Port x Configuration menu, change other port parameters according to your network specifications or keep their default values. Choose **S** to save the configuration.

➤ **Add IP interface for subnet 2**

1. In the IP Interface Configuration menu, choose **1** (Add IP Interface Entry).

```

IP Interface Configuration
-----
1) Add IP Interface Entry.
2) Delete IP Interface Entry.
3) Update IP Interface Entry.
4) Display IP Interface Entry.
CR) Exit.

Select:

```

Type a new IP Interface number for the Frame Relay connection.

2. In the IP Interface x Configuration menu, choose **4** (Destination). Set the destination to subnet 2 (Frame Relay) using the Port:DLCI according to Frame Relay network specifications.

```

4) Destination
-----
Current value ... [No Destination]

Possible values:
No Destination: 'N'
X.25 PVC   :   Port:LCN
X.25 SVC   :   X25 Addr or 'cid' followed by a predefined call ID number
Frame Relay: Port:DLCI
HDLC       :   'H' followed by the HDLC port number
SLIP       :   'S' followed by the SLIP port number
PPP        :   'P' followed by the PPP port number
BUNDLE     :   'B' followed by the PPP Bundle number
Ethernet   :   'E' followed by the Ethernet port number

Enter one of the above values or <RETURN> to exit:

```

3. Choose **S** to save the configuration.

➤ **Add an IP Routing table entry for the link to Subnet 2**

1. Press **ENTER** several times so that the Configuration menu reappears. In the Configuration menu, choose **14** (IP configuration).

```

Configuration Menu
-----
1)Channel
2)Profile
3)Link
4)System parameters
5)PVC
6)Call ID
7)NUI
8)Alias
9)Routing table
10)Funnel
11)X.23
12)Management
13)Multicast
14)IP Configuration
15)ISDN configuration
16)SNA
CR)Exit

Select:

```

2. In the IP Configuration menu, choose **3** (IP static route).

```

IP Configuration
-----
1) IP global parameters.
2) IP interface.
3) IP static route.
CR) Exit

Select:

```

3. In the IP static route menu, choose **1** (Add IP Static Entry).

```

IP Static Configuration
-----
1) Add IP Static Entry.
2) Delete IP Static Entry.
3) Update IP Static Entry.
4) Display IP Static Entry.
CR) Exit.

Select:
  
```

4. Existing IP Static is shown. Enter IP Static number (e.g. 1).

```

Existing IP Static: None

Enter IP Static number (1..200):1
  
```

5. In the IP Static 1 Configuration menu, choose **1** (IP address).

```

IP Static 1      Configuration
-----
1) IP address ..... [0.0.0.0]
2) IP mask ..... [255.255.255.255]
3) Destination Interface ..... [ 0 ]
4) Metric ..... [ 1 ]
5) Next hop ..... [0.0.0.0]
S) Save.
CR) Exit.

Select:
  
```

6. In the IP Address screen, In the IP Address screen, type the IP Address of Subnet 2 (**100.10.2.0**).

```

1) IP Address
-----
Current value ... [0.0.0.0]

Possible values:
A string of the format: X.X.X.X
Where every X is a number in the range 0 - 255.

Enter one of the above values or <RETURN> to exit:
  
```

7. In the IP static 1 Configuration menu, choose **2** (IP mask).

```

IP Static 1      Configuration
-----
1) IP address ..... [100.10.2.0]
2) IP mask ..... [255.255.255.255]
3) Destination Interface ..... [ 0 ]
4) Metric ..... [ 1 ]
5) Next hop ..... [0.0.0.0]
S) Save.
CR) Exit.

Select:
  
```

8. In the IP Mask screen, type the IP Mask of Subnet 1 (**255.255.255.0**).

```

2) IP mask
-----
Current value ... [255.255.255.255]

Possible values:
A string of the format: X.X.X.X
Where every X is a number in the range 0 - 255.

Enter one of the above values or <RETURN> to exit:
  
```

9. In the IP static 1 Configuration menu, choose **3** (Destination Interface).

```

IP Static 1      Configuration
-----
1) IP address ..... [100.10.2.0]
2) IP mask ..... [255.255.255. 0]
3) Destination Interface ..... [ 0 ]
4) Metric ..... [ 1 ]
5) Next hop ..... [0.0.0.0]
S) Save.
CR) Exit.

Select:

```

10. In the Destination Interface screen, type the number of the pre-configured destination IP interface.

```

3) Destination Interface
-----
Current value ... [ 0 ]

Possible values:
Any existing IP Interface or 0 for No Destination.

Enter one of the above values or <RETURN> to exit:

```

11. In the IP static xx Configuration menu, the IP static for the link to subnet 1 is as follows:

```

IP static 1      Configuration
-----
1) IP address ..... [100.10.2.0]
2) IP mask ..... [255.255.255. 0]
3) Destination Interface ..... [ 1 ]
4) Metric ..... [ 1 ]
5) Next hop ..... [0.0.0.0]
S) Save.
CR) Exit.

Select:

```

Choose **S** to save the configuration.

➤ **Add IP interface for ISP connection**

1. In the IP Interface Configuration menu, choose **1** (Add IP Interface Entry).

```

IP Interface Configuration
-----
1) Add IP Interface Entry.
2) Delete IP Interface Entry.
3) Update IP Interface Entry.
4) Display IP Interface Entry.
CR) Exit.

Select:

```

Type a new IP Interface number for the ISP connection.

2. In the IP Interface x Configuration menu, choose **4** (Destination). Set the destination to Frame Relay using the Port:DLCI according to the ISP specifications.

```

4) Destination
-----
Current value ... [No Destination]

Possible values:
No Destination: 'N'
X.25 PVC      : Port:LCN
X.25 SVC      : X25 Addr or 'cid' followed by a predefined call ID number
Frame Relay   : Port:DLCI
HDLC          : 'H' followed by the HDLC port number
SLIP          : 'S' followed by the SLIP port number
PPP           : 'P' followed by the PPP port number
BUNDLE        : 'B' followed by the PPP Bundle number
Ethernet      : 'E' followed by the Ethernet port number

Enter one of the above values or <RETURN> to exit:

```

3. Choose **S** to save the configuration.

➤ **Add an IP Routing table entry for the link to the ISP**

1. Press **ENTER** several times so that the IP Routing Configuration menu reappears. In the IP Configuration menu, choose **3** (IP Static Route). In IP Static Configuration menu, Choose 1. Type an IP static entry number for the link to the ISP and press **ENTER**.
2. In the IP Static xx Configuration menu, keep the default values for the IP Address and configure the IP Mask to **0.0.0.0**.
3. In the IP Static xx Configuration menu, choose **4** (Destination). In the Destination screen, type the number of the pre-configured IP interface.
4. In the IP Static xx Configuration menu, the IP routing for the link to the ISP is as follows:

```

IP static 200      Configuration

1) IP address ..... [0.0.0.0]
2) IP mask ..... [255.255.255.255]
3) Destination Interface ..... [ 4 ]
4) Metric ..... [ 1 ]
5) Next hop ..... [0.0.0.0]
S) Save.
CR) Exit.

Select:

```

Choose **S** to save the configuration.

➤ **Add IP interface for subnet 3**

1. In the IP Interface Configuration menu, choose **1** (Add IP Interface Entry).

```

IP Interface Configuration
-----

1) Add IP Interface Entry.
2) Delete IP Interface Entry.
3) Update IP Interface Entry.
4) Display IP Interface Entry.
CR) Exit.

Select:

```

Type a new IP Interface number for subnet 3 connection.

2. In the IP Interface x Configuration menu, choose **4** (Destination). Set the destination to **X.25 SVC** using X.25 address.

```

4) Destination
-----
Current value ... [No Destination]

Possible values:
No Destination: 'N'
X.25 PVC      :   Port:LCN
X.25 SVC      :   X25 Addr or 'cid' followed by a predefined call ID number
Frame Relay:   Port:DLCI
HDLC          :   'H' followed by the HDLC port number
SLIP          :   'S' followed by the SLIP port number
PPP           :   'P' followed by the PPP port number
BUNDLE        :   'B' followed by the PPP Bundle number
Ethernet      :   'E' followed by the Ethernet port number

Enter one of the above values or <RETURN> to exit:

```

3. Choose **S** to save the configuration.

➤ **Add an IP Routing table entry for the link to Subnet 3**

1. Press **ENTER** several times so that the IP Routing Configuration menu reappears. In the IP Configuration menu, choose **3** (IP Static Route). In IP Static Configuration menu, Choose 1. Type an IP static entry number for the link to Subnet 2 and press **ENTER**.
2. In the IP Static xx Configuration menu, choose **1** (IP Address). In the IP Address screen, type the IP Address of Subnet 2 (**100.10.3.0**).
3. In the IP Mask screen, type the IP Mask of Subnet 2 (**255.255.255.0**).
4. In the IP Static xx Configuration menu, choose **4** (Destination). In the Destination screen, type the number of the relevant IP interface for Subnet 3.
5. In the IP static xx Configuration menu, the IP static for the link to Subnet 3 is as follows:

```

IP static 2      Configuration

1) IP address ..... [100.10.2.0]
2) IP mask ..... [255.255.255.0]
3) Destination Interface ..... [ 2 ]
4) Metric ..... [ 1 ]
5) Next hop ..... [0.0.0.0]
S) Save.
CR) Exit.

Select:

```

- Choose **S** to save the configuration.

## 2.22 LAN Ethernet Application (Bridging)

Connecting an Ethernet LAN through packet switches in a bridging configuration over X.25 and Frame Relay networks.

This section describes configuration procedures of a packet switch in a LAN Ethernet bridging application. These procedures include:

- Select a link that connects to an Ethernet network (Link 9)
- Define the operation mode of the Ethernet link
- Define the destination(s) of the traffic received on the Ethernet link

**Note**

*This task requires you to perform one of the following optional procedures.*

- Define a single destination for all traffic received on the Ethernet link
- Define specific destinations using a filter table
- Build a global destination configuration table.

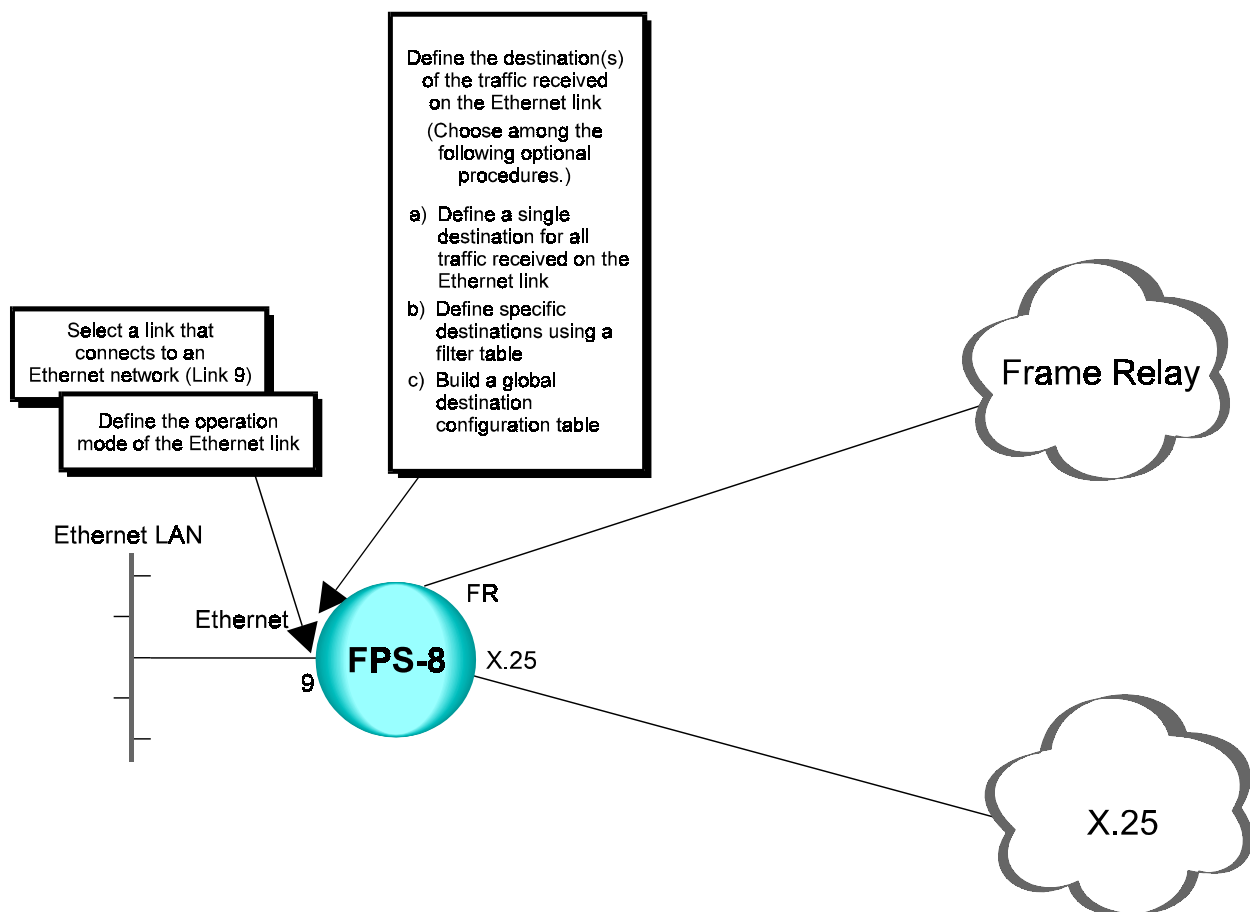



**Note**

*This application requires prior installation of a IR-ETH interface card in the following synchronous links, depending on the packet switch models used in your application:*

*For SPS-12 - link no. 1 or 7.*

*For SPS-3S, SPS-6 - link no. 1.*

*For APS devices - any link.*

*For FPS-8 - links no. 9 and 10*

*Any external Tiny Bridge can also be used in any other link.*

**Terminal Configuration Procedures**

This section describes terminal configuration procedures of a packet switch in an Ethernet bridging application.

**► Select a link that connects to an Ethernet network (Link 9)**

In this application, link 9 is connected to an Ethernet LAN.

1. In the Configuration menu, choose **3** (Link).

```
Configuration menu
-----
1) Channel
2) Profile
3) Link
4) System parameters
5) PVC
6) Call ID
7) NUI
8) Alias
9) Routing table
10) Funnel
11) X.32
12) Management
13) Multicast
14) IP configuration
15) ISDN configuration
16) SNA
CR) Exit

Select:
```

2. In the Link Configuration menu, choose **3** (Update Link Parameters).

```
Link configuration
-----
1) Set Link type.
2) Display Links protocols.
3) Update Link parameters.
4) Display Links parameters.
CR) Exit

Select:
```

- Choose the number of the Ethernet link that you want to configure (Link 9).

```

Link | 1 | 2 | 3 | 4 | 5 | 6 | 7 | 8 | 9 | 10
|-----|-----|-----|-----|-----|-----|-----|-----|-----|-----|
|
|
Prot |X.25 |X.25 |X.25 |X.25 |X.25 |X.25 |X.25 |X.25
|ETHER|ETHER|

```

▶ Enter Link number to set:

The Ethernet Link x Configuration menu appears.

▶ **Define the operation mode of the Ethernet link**

- In the Ethernet Link x Configuration menu, choose **1** (Operation Mode).

```

Ethernet Link 9 configuration
-----
1) Operation mode.
2) Interface configuration.
3) Bridging configuration.
CR) Exit

Select:

```

▶

- In the Operation Mode menu, choose **1** (IP Handling).

```

Operation Mode
-----
1) IP handling ..... [ 1 ]
2) LLC handling ..... [ 0 ]
3) Bridging handling ..... [ 0 ]
S) Save.
CR) Exit

Select:

```

▶

- In the IP Handling screen, choose **0** (Disable) to disable the IP operation mode.

```

1) IP handling
-----
Current value ... [ 0 ]

Possible values:
0 - Disable
1 - Enable

Enter one of the above values or <RETURN> to exit:

```

▶

- In the Operation Mode menu, choose **3** (Bridging Handling).

5. In the Bridging Mode screen, choose **1** (Enable) to make the Bridging mode active.

```
3) Bridging mode
-----
Current value ... [ 1 ]

Possible values:
0 - Disable
1 - Enable

Enter one of the above values or <RETURN> to exit:
```

6. In the Operation Mode menu, choose **S** to save the configuration.

► **Define the destination(s) of the traffic received on the Ethernet link**

To perform this task, you may choose between three optional procedures:

- a) Define a single destination for all traffic received on the Ethernet link
- b) Define specific destinations using a filter table
- c) Build a global destination configuration table.
  - Procedures (a) and (b) are mutually exclusive. If procedure (a) is used, its result always overrides the results of procedure (b).
  - Procedure (c) may or may not be used. However, it provides a contingency for determining a destination if the data packet's destination does not appear in the filter table.

**a) Define a single destination for all traffic received on the Ethernet link**

Use this optional procedure to define a single destination for all packets received by the Ethernet link, regardless of the packets' contents and specified destination.

1. Press ENTER to return to the Ethernet Link x Configuration menu. In the Ethernet Link x Configuration menu, choose **3** (Bridging Configuration).

```
Ethernet Link 9 configuration
-----
1) Operation mode.
2) Interface configuration.
3) Bridging configuration.
CR) Exit

Select:
```

- In the Bridging Configuration screen, choose **D** (Point to Point Destination).

```

Bridging Configuration
-----
Active only if Bridging Handling is enabled*.
          STATUS: Enabled
D) Point to Point destination ..... [No Dest]

Filter Table
=====
ID|Dest MAC Address| Protocol Type | Destination
--|-----|-----|-----
1|
2|
3|
4|
5|
6|
7|
8|
9|
10|
S) Save.
CR) Exit
Select:

```

- In the Point to Point Destination screen, type the destination to which the device routes the data packets, regardless of the contents and parameters of the packets.

```

          D) Point to point destination
          -----
Current value ... [No Dest]

Possible values:
X.25 PVC:      Port:LCN
X.25 SVC:      X.25 Addr or 'cid' followed by a predefined
                Call ID number
Frame Relay:   Port:DLCI
No Destination: 0

Enter one of the above values or <RETURN> to exit:

```

**Note** *The Point to Point destination always overrides the filter table entries.*

- In the Bridging Configuration screen, choose **S** to save the configuration.

### b) Define specific destinations using a filter table

Use this procedure for sending data to different locations. In this case, each destination MAC address is translated to a specific destination interface.

1. Press ENTER to return to the Ethernet Link x Configuration menu. In the Ethernet Link x Configuration menu, choose **3** (Bridging Configuration).
2. In the Bridging Configuration screen, choose an ID number of a filter table entry (**1 to 10**).

```

Bridging Configuration
-----
Active only if Bridging Handling is enabled*.
          STATUS: Enabled

D) Point to Point destination ..... [No Dest]

Filter Table
=====
ID|Dest MAC Address| Protocol Type | Destination
--|-----|-----|-----
1|
2|
3|
4|
5|
6|
7|
8|
9|
10|
S) Save.
CR) Exit
Select:

```

3. In the Filter Table Entry screen, define all the parameters of the new filter table entry.
  - Choose **1** (Dest MAC Address) to define the MAC address of the destination equipment.
  - Choose **2** (Protocol Type) to define the type of protocol to filter.
  - Choose **3** (Destination) to define the destination of the filtered frame.

```

Filter Table -Entry 1
-----
1) Dest MAC Address ..... [  ]
2) Protocol Type ..... [  ]
3) Destination ..... [  ]
S) Save.
CR) Exit
Select:

```

4. In the Filter Table Entry screen, choose **S** to save the entry.
5. To define other Filter Table entries, repeat steps 2 to 4 of this procedure as many times as necessary.
6. In the Bridging Configuration screen, choose **S** to save the configuration.

### c) Build a global destination configuration table

Use this procedure to create an alternate destination for packets whose destination MAC address does not exist in the filter table. In this case, the device sends these packets to all locations defined in the Ethernet Global Parameters table.

**Note** *The parameters in the Ethernet Global Parameters table are valid for all Ethernet links on the device.*

1. Press ENTER several times so that the Configuration menu reappears. In the Configuration menu, choose **4** (System Parameters).

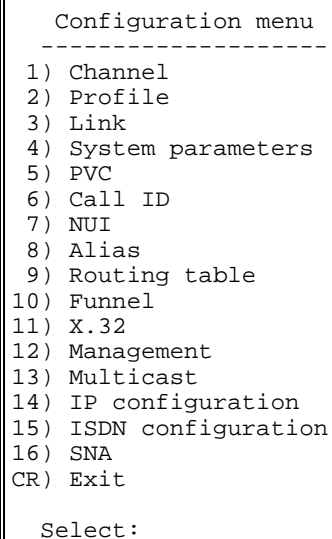

```
Configuration menu
-----
1) Channel
2) Profile
3) Link
4) System parameters
5) PVC
6) Call ID
7) NUI
8) Alias
9) Routing table
10) Funnel
11) X.32
12) Management
13) Multicast
14) IP configuration
15) ISDN configuration
16) SNA
CR) Exit

Select:
```

2. In the System Configuration menu, choose **3** (Ethernet Global Parameters).

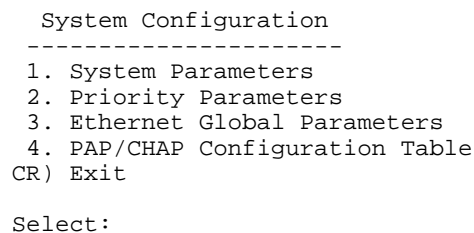

```
System Configuration
-----
1. System Parameters
2. Priority Parameters
3. Ethernet Global Parameters
4. PAP/CHAP Configuration Table
CR) Exit

Select:
```

- According to your network specifications, configure X.25 and/or Frame Relay bridging destinations. In the Ethernet Global Parameters screen, choose the appropriate ID number (**3** to **12** for X.25 destinations, **13** to **22** for FR destinations).

```

Ethernet Global Parameters
-----
1) Enable WAN to WAN ... [0  ]
2) Global Timer ..... [0  ]

X25 Bridging Destinations          FR Bridging Destinations
=====|=====
3)                                     13)
4)                                     14)
5)                                     15)
6)                                     16)
7)                                     17)
8)                                     18)
9)                                     19)
10)                                    20)
11)                                    21)
12)                                    22)

S) Save
CR) Exit

Select:

```

- According to your selection (X.25 and/or FR), type a valid destination address for any packets that will use this global configuration.

```

3 ) X25 Bridging Destination
-----
Current value ... [      ]

Possible values:
X.25 PVC:      Port:LCN
X.25 SVC:      X.25 Addr or 'cid' followed by a predefined
                Call ID number

Enter one of the above values or <RETURN> to exit:

```

```

13) FR Bridging Destination
-----
Current value ... [      ]

Possible values:
Frame Relay:   Port:DLCI

Enter one of the above values or <RETURN> to exit:

```

- To define additional global entries, repeat steps 3 and 4 of this procedure as many times as necessary.
- In the Ethernet Global Parameters screen, choose **S** to save the configuration.

---

## 2.23 IP Switching Application

Connecting users on subnets to an Internet Service Provider (ISP) over a Frame Relay network.

This appendix describes typical configuration procedures for a packet switch in an IP Switching application. These procedures include:

- Set three links to Frame Relay
- Set the Frame Relay Link 1 port parameters
- Set the Frame Relay Link 2 port parameters
- Set the Frame Relay Link 3 port parameters
- Configure an X.25 link that connects to a host computer
- Set SNMP management parameters
- Add IP Interfaces
- Add IP Static Routing
- Add a routing table entry for the X.25 link



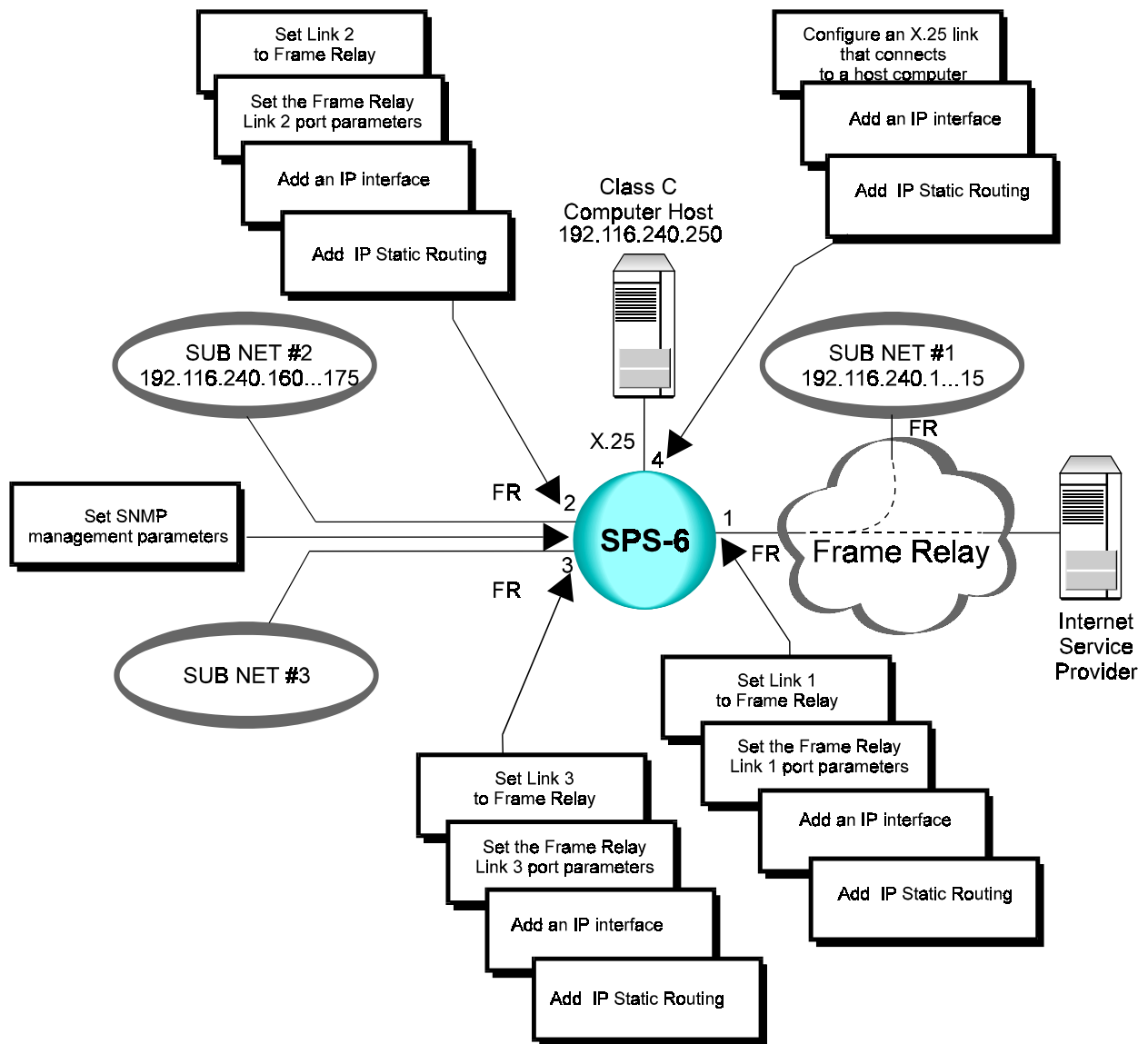

**Note** *The specific IP addresses and masks in this section are hypothetical and do not reflect an actual configuration. For your application, substitute the appropriate IP addresses and masks in place of those specified in this section.*

## Terminal Configuration Procedures



The following steps describe the configuration procedures for connecting users on subnets to an Internet Service Provider (ISP) over a Frame Relay network by using a packet switch in an IP Switching application.

### ➤ Set three links to Frame Relay

Set the following links to Frame Relay:

- Link 1 - Connects to the Frame Relay network, Subnet 1 and the ISP
- Link 2 - Connects to Subnet 2
- Link 3 - Connects to Subnet 3

- See Section 3.3, “Terminal Configuration Procedures, ➤ Set a link to Frame Relay.” Perform all steps as instructed for the above links.

### ➤ Set the Frame Relay Link 1 port parameters

- See Section 3.3, “Terminal Configuration Procedures, ➤ Set the Frame Relay port parameters.” Perform steps 1 to 5 of the procedure. Afterwards, perform the following steps:

1. In the Maintenance Protocol Mode screen, choose **0** (User-side).

2) Maintenance protocol mode

This field defines the mode of maintenance protocol running over this port.  
Current value.. [1 ]

Possible values:

- 0 - Perform user-side procedure on this port.
- 1 - Perform network-side procedure on this port.
- 2 - Perform NNI (Network to Network Interface) procedure on this port.

Enter one of the above values or <RETURN> to exit:

2. In the Frame Relay Port x Configuration menu, change other port parameters according to your network specifications or keep their default values. Choose **S** to save the configuration.

### ➤ Set the Frame Relay Link 2 port parameters

- See Section 3.3, “Terminal Configuration Procedures, ➤ Set the Frame Relay port parameters.” Perform all steps as instructed.

### ➤ Set the Frame Relay Link 3 port parameters

- See Section 3.3, “Terminal Configuration Procedures, ➤ Set the Frame Relay port parameters.” Perform all steps as instructed.

### ➤ Configure an X.25 link that connects to a host computer

- See Section 3.2, “Configuration Procedures (Terminal), ➤ Select an X.25 link,” and “➤ Set X.25 link parameters.” Perform all steps as instructed.

➤ **Set SNMP management parameters**

This procedure is required to enable SNMP management of this packet switch from a network management station at a remote site.

1. Press **ENTER** several times so that the Configuration menu reappears. In the Configuration menu, choose **12** (Management).

```
Configuration Menu
-----
1)Channel
2)Profile
3)Link
4)System parameters
5)PVC
6)Call ID
7)NUI
8)Alias
9)Routing table
10)Funnel
11)X.23
12)Management
13)Multicast
14)IP Configuration
15)ISDN configuration
16)SNA
CR)Exit

Select:
```

2. In the Management Configuration menu, choose **1** (SNMP Agent).

```
Management configuration
-----
1) SNMP Agent
2) Event Report
CR) Exit

Select:
```

3. In the SNMP Agent menu, choose **1** (Agent IP Configuration).

```
SNMP Agent
-----
1) Agent IP Configuration.
2) MIB System Group.
3) Management Stations.
CR) Exit

Select:
```

4. In the Agent IP Configuration menu, choose **1** (IP Address).

```

Agent IP Configuration
1) IP Address [0.0.0.0.]
2) Authentication Trap ..... [0 ]
3) IP Write Community ..... [ ]
4) IP Read Community ..... [public]
5) IP Trap Community ..... [ ]
S) Save
CR) Exit

Select:
  
```

5. In the IP Address screen, type the IP address of the packet switch.

```

1) IP Address

Current value [0.0.0.0.]

Possible values:
A string of the format: X.X.X.X
Where every X is a number in the range 0 - 255.

Enter one of the above vales or <RETURN> to exit:
  
```

6. In the Agent IP Configuration menu, choose **3** (IP Write Community). In the IP Write Community screen, type **netman**.

```

3) IP Write Community

Current value [ ]

Possible values:
Up to 20 characters

Enter one of the above vales or <RETURN> to exit:
  
```

7. In the Agent IP Configuration menu, choose **5** (IP Trap Community). In the IP Trap Community screen, type **public**.

```

5) IP Trap Community

Current value [ ]

Possible values:
Up to 20 characters

Enter one of the above vales or <RETURN> to exit:
  
```

8. In the Agent IP Configuration menu, choose **S** to save the configuration.

9. Press ENTER several times so that the SNMP Agent menu reappears. In the SNMP Agent menu, choose **3** (Management Stations).

```

SNMP Agent

1) Agent IP Configuration.
2) MIB System Group.
3) Management Stations.
CR) Exit

Select:

```

10. In the Management Station Configuration menu, choose **1** (Add Management Station).

```

Management Station Configuration

1) Add Management Station.
2) Delete Management Station.
3) Update Management Station.
4) Display Management Station.
CR) Exit

Select:

```

11. In the Management Station x Configuration menu, choose **1** (Management Station IP Address).

```

Management Station 1 Configuration

1) Management station IP Address [100.10.2.0]
2) Management station Trap Options [0 ]
S) Save
CR) Exit

Select:

```

12. In the Management Station IP Address screen, type the IP Address of your management station.

```

1) Management Station IP Address
-----
Current value [0.0.0.0]
Possible values:
A string of the format: X.X.X.X
Where every X is a number in the range 0 - 255.
Enter one of the above vales or <RETURN> to exit:

```

13. In the Management Station x Configuration menu, choose **2** (Management Station Trap Options). In the Management Station Trap Options screen, add the values of the trap types that you want to receive at the network management station.

```

2) Management Station Trap Options

This value indicates which traps should be sent.
The value is a sum of values (powers of two), where each value in
the sum represents a trap that should be reported to the Management
station. The values that may be included in the sum and their
meaning are:

    Current value ..... [0    ]

Possible values:
0 - No Traps would be reported           32 - frDLCIStatusChange.
1 - Link Down                             64 - coldStart
2 - Link Up                               128 - linkProtocolChange.
4 - rtsChange                             256 - enrollmentPS.
8 - reset X.25                             512 - ledStatusChange.
16 - restart X.25
Enter one of the above vales or <RETURN> to exit:

```

For example, the value **75** (1 + 2 + 8 + 64) indicates that the network management station receives traps 1, 2, 8 and 64.

14. In the Management Station x Configuration menu, choose **S** to save the configuration.

➤ **Add IP interfaces**

1. Press **ENTER** several times so that the Configuration menu reappears. In the Configuration menu, choose **14** (IP Configuration).

```

Configuration Menu
-----
1)Channel
2)Profile
3)Link
4)System parameters
5)PVC
6)Call ID
7)NUI
8)Alias
9)Routing table
10)Funnel
11)X.23
12)Management
13)Multicast
14)IP Configuration
15)ISDN configuration
16)SNA
CR)Exit

Select:

```

2. In the IP Configuration menu, choose **2** (IP interface).

```

IP Configuration
-----
1) IP global parameters.
2) IP interface.
3) IP static route.
CR) Exit

Select:

```

3. In the IP Interface Configuration menu, choose **1** (Add IP Interface Entry).

```

IP Interface Configuration
-----
1) Add IP Interface Entry.
2) Delete IP Interface Entry.
3) Update IP Interface Entry.
4) Display IP Interface Entry.
CR) Exit.

Select:

```

4. The existing IP Interfaces appear. Enter IP Interface number (e.g. 1).

```

Existing IP Interfaces : 159,160

Enter IP Interface number (1..200):1

```

**Note**

*IP interfaces 159 and 160 are created automatically.*

5. In the IP Interface 1 Configuration menu, choose **4** (Destination).

```

IP Interface 1 Configuration
-----
1) IP address ..... [0.0.0.0]
2) IP mask ..... [255.255.255.255]
3) RIP mode ..... [ 0 ]
4) Destination ..... [No Destination]
5) Default route metric ..... [Disabled]
6) Inactivity timer ..... [ ]
7) Link cost ..... [ 1 ]
8) Subnet learning mask ..... [0.0.0.0]
9) Options ..... [ 0 ]
S) Save.
CR) Exit.

Select:

```

6. In the Destination screen, Enter the destination link number and DLCI number (e.g. 1:16).

```

4) Destination
-----
Current value ... [No Destination]

Possible values:
No Destination: 'N'
X.25 PVC      : Port:LCN
X.25 SVC      : X25 Addr or 'cid' followed by a predefined call ID number
Frame Relay   : Port:DLCI
HDLC          : 'H' followed by the HDLC port number
SLIP          : 'S' followed by the SLIP port number
PPP           : 'P' followed by the PPP port number
BUNDLE        : 'B' followed by the PPP Bundle number
Ethernet      : 'E' followed by the Ethernet port number

Enter one of the above values or <RETURN> to exit: 1:16

```

7. Repeat steps 5 to 6 for the other required interfaces .  
 For example:  
 IP interface 1 - destination 1:16  
 IP interface 2 - destination 2:25  
 IP interface 3 - destination 3:25  
 IP interface 4 - destination 566231 (X.25 interface)

8. In the IP Interface 1 Configuration menu, choose **S** (Save).

```

IP Interface 1      Configuration
-----
1) IP address ..... [0.0.0.0]
2) IP mask ..... [255.255.255.255]
3) RIP mode ..... [ 0 ]
4) Destination ..... [1:16]
5) Default route metric ..... [Disabled]
6) Inactivity timer ..... [ ]
7) Link cost ..... [ 1 ]
8) Subnet learning mask ..... [0.0.0.0]
9) Options ..... [ 0 ]
S) Save.
CR) Exit.

Select:

```



➤ **Add an IP Static Routing entry for the link to Subnet 1**

1. Press **ENTER** several times so that the Configuration menu reappears. In the Configuration menu, choose **14** (IP configuration).

```

Configuration Menu
-----
1)Channel
2)Profile
3)Link
4)System parameters
5)PVC
6)Call ID
7)NUI
8)Alias
9)Routing table
10)Funnel
11)X.23
12)Management
13)Multicast
14)IP Configuration
15)ISDN configuration
16)SNA
CR)Exit

Select:

```

2. In the IP Configuration menu, choose **3** (IP static route).

```

IP Configuration
-----
1) IP global parameters.
2) IP interface.
3) IP static route.
CR) Exit

Select:

```

3. In the IP static route menu, choose **1** (Add IP Static Entry).

```

IP Static Configuration
-----
1) Add IP Static Entry.
2) Delete IP Static Entry.
3) Update IP Static Entry.
4) Display IP Static Entry.
CR) Exit.

Select:

```

4. Existing IP Static is shown. Enter IP Static number (e.g. 1).

```

Existing IP Static: None

Enter IP Static number (1..200):1

```

5. In the IP Static 1 Configuration menu, choose **1** (IP address).

```

IP Static 1 Configuration
-----
1) IP address ..... [0.0.0.0]
2) IP mask ..... [255.255.255.255]
3) Destination Interface ..... [ 0 ]
4) Metric ..... [ 1 ]
5) Next hop ..... [0.0.0.0]
S) Save.
CR) Exit.

Select:

```

6. In the IP Address screen, In the IP Address screen, type the IP Address of Subnet 1 (**192.116.240.1**).

```

1) IP Address
-----
Current value ... [0.0.0.0]

Possible values:
A string of the format: X.X.X.X
Where every X is a number in the range 0 - 255.

Enter one of the above values or <RETURN> to exit: 192.116.240.1

```

7. In the IP static 1 Configuration menu, choose **2** (IP mask).

```

IP Static 1      Configuration
-----
1) IP address ..... [192.116.240.1]
2) IP mask ..... [255.255.255.255]
3) Destination Interface ..... [ 0 ]
4) Metric ..... [ 1 ]
5) Next hop ..... [0.0.0.0]
S) Save.
CR) Exit.

Select:

```

8. In the IP Mask screen, type the IP Mask of Subnet 1 (**255.255.255.240**).

```

2) IP mask
-----
Current value ... [255.255.255.255]

Possible values:
A string of the format: X.X.X.X
Where every X is a number in the range 0 - 255.

Enter one of the above values or <RETURN> to exit: 255.255.255.240

```

9. In the IP static 1 Configuration menu, choose **3** (Destination Interface).

```

IP Static 1      Configuration
-----
1) IP address ..... [192.116.240.1]
2) IP mask ..... [255.255.255.240]
3) Destination Interface ..... [ 0 ]
4) Metric ..... [ 1 ]
5) Next hop ..... [0.0.0.0]
S) Save.
CR) Exit.

Select:

```

10. In the Destination Interface screen, type the number of the pre-configured destination IP interface (e.g. 1).

```

3) Destination Interface
-----
Current value ... [ 0 ]

Possible values:
Any existing IP Interface or 0 for No Destination.

Enter one of the above values or <RETURN> to exit:

```

11. In the IP static xx Configuration menu, the IP static for the link to subnet 1 is as follows:

```

IP static 1      Configuration
-----
1) IP address ..... [192.116.240.1]
2) IP mask ..... [255.255.255.240]
3) Destination Interface ..... [ 1 ]
4) Metric ..... [ 1 ]
5) Next hop ..... [0.0.0.0]
S) Save.
CR) Exit.

Select:

```

choose **S** to save the configuration.

➤ **Add IP Routing table entries for the links to Subnets 2 and 3**

1. Press **ENTER** several times so that the IP Routing Configuration menu reappears. In the IP Configuration menu, choose **3** (IP Static Route). In IP Static Configuration menu, Choose 1. Type an IP static entry number for the link to Subnet 2 and press **ENTER**.
2. In the IP Static xx Configuration menu, choose **1** (IP Address). In the IP Address screen, type the IP Address of Subnet 2 (**192.116.240.160**).
3. In the IP Mask screen, type the IP Mask of Subnet 2 (**255.255.255.240**).
4. In the IP Static xx Configuration menu, choose **4** (Destination). In the Destination screen, type the number of the relevant IP interface for Subnet 2.
5. In the IP static xx Configuration menu, the IP static for the link to Subnet 2 is as follows:

```

IP static 2      Configuration
-----
1) IP address ..... [192.116.240.160]
2) IP mask ..... [255.255.255.240]
3) Destination Interface ..... [ 2 ]
4) Metric ..... [ 1 ]
5) Next hop ..... [0.0.0.0]
S) Save.
CR) Exit.

Select:

```

Choose **S** to save the configuration.

6. To define an IP Static Routing Table entry for the link to Subnet 3, repeat steps 1 to 5 above.

➤ **Add an IP Routing table entry for the X.25 link**

1. Press **ENTER** several times so that the IP Routing Configuration menu reappears. In the IP Configuration menu, choose **3** (IP Static Route). In IP Static Configuration menu, Choose 1. Type an IP static entry number for the link to Subnet 4 and press **ENTER**.
2. In the IP Static xx Configuration menu, choose **1** (IP Address). In the IP Address screen, type the IP Address of the host computer connected to the X.25 link (**192.116.240.250**).

3. In the IP Static xx Configuration menu, choose **4** (Destination). In the Destination screen, type the X.25 address of the connected host computer.
4. In the IP Routing xx Configuration menu, the IP routing for the X.25 link is as follows:

```

IP static 2      Configuration
-----
1) IP address ..... [192.116.240.250]
2) IP mask ..... [255.255.255.255]
3) Destination Interface ..... [ 4 ]
4) Metric ..... [ 1 ]
5) Next hop ..... [0.0.0.0]
S) Save.
CR) Exit.

Select:

```

Choose **S** to save the configuration.

➤ **Add an IP Routing table entry for the link to the ISP**

1. Press **ENTER** several times so that the IP Routing Configuration menu reappears. In the IP Configuration menu, choose **3** (IP Static Route). In IP Static Configuration menu, Choose 1. Type an IP static entry number for the link to the ISP and press **ENTER**.

**Note**

*The default IP routing entry number for the link to the ISP is **200**.*

2. In the IP Static xx Configuration menu, keep the default values for the IP Address and the IP Mask.
3. In the IP Static xx Configuration menu, choose **4** (Destination). In the Destination screen, type the Frame Relay port and DLCI of the ISP.
4. In the IP Static xx Configuration menu, the IP routing for the link to the ISP is as follows:

```

IP static 200    Configuration
-----
1) IP address ..... [0.0.0.0]
2) IP mask ..... [255.255.255.255]
3) Destination Interface ..... [ 4 ]
4) Metric ..... [ 1 ]
5) Next hop ..... [0.0.0.0]
S) Save.
CR) Exit.

Select:

```

Choose **S** to save the configuration.

➤ **Add a routing table entry for the X.25 link**

In the X.25 link, the routing destination is the connected host computer.

- See Section 3.2, “Terminal Configuration Procedures, ➤ Add a routing table entry.” Perform all steps as instructed.

---

---

## 2.24 Routing IP Application (RIP)

When using the RIP protocol, packet switches devices transfer between them routing information. This enables the packet switches devices to adjust themselves to changes in the network topology.

This section describes configuration procedures of a packet switch in a RIP application. These procedures include:

- Select link type to Ethernet
- Set two links to Frame Relay
- Configure Links 1 and 2 port parameters
- Configure IP agent
- Configure IP interface

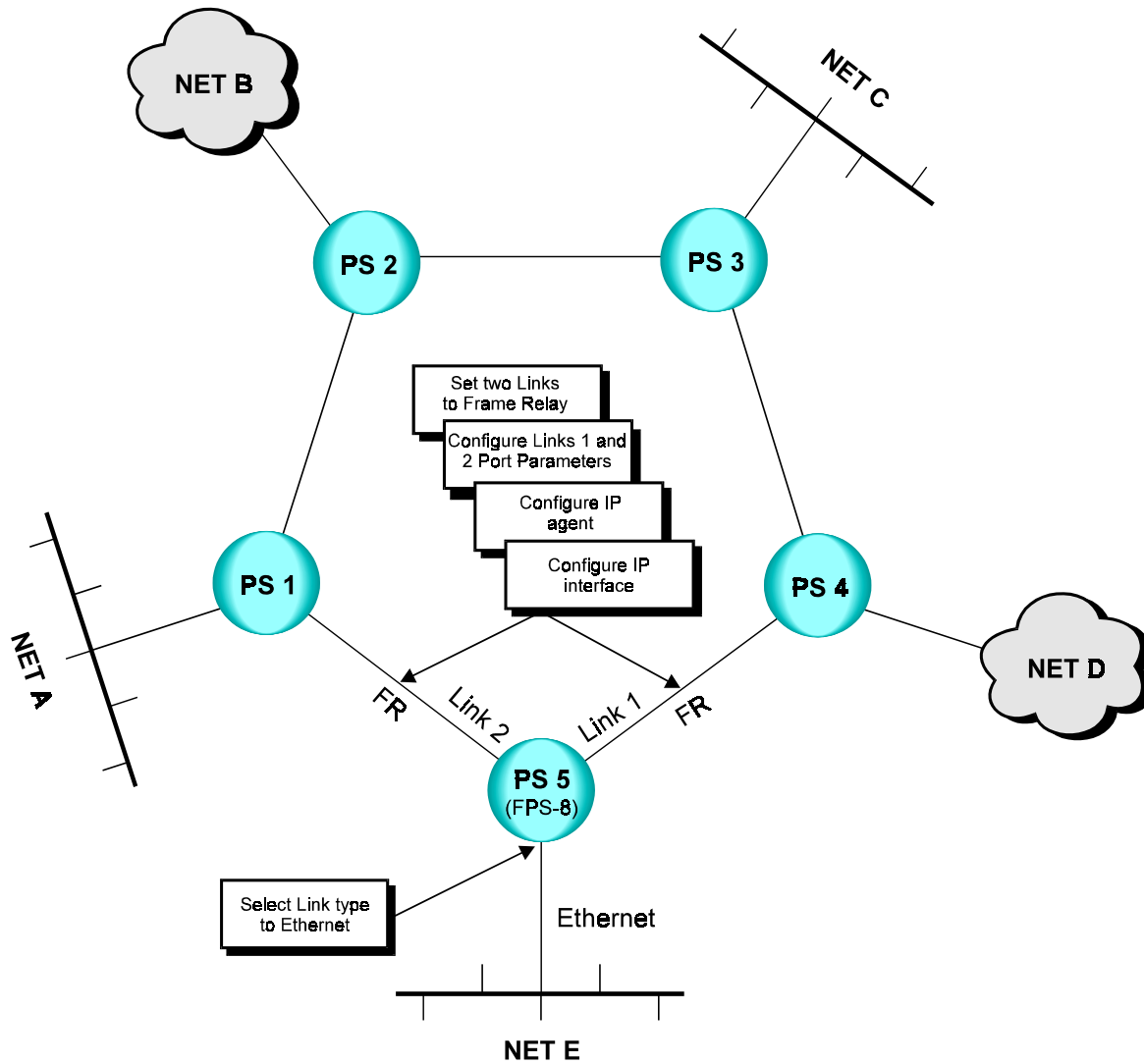
**Note**

This application requires prior installation of a IR-ETH interface card in the following synchronous links, depending on the packet switch models used in your application:

For SPS-12 - link no. 1 or 7.

For SPS-3S, SPS-6 - link no. 1.

For APS devices - any link.

For FPS-8 - links no. 9 and 10

Any external Tiny Bridge can also be used in any other link.

## Terminal Configuration Procedures



This section describes terminal configuration procedures of a packet switch in a RIP application. (For FPS-8 configuration skip the procedure “► Select a link that connects to an Ethernet network”)

### ► Select a link that connects to an Ethernet network

In this application, link 1 is connected to an Ethernet LAN.

1. In the Configuration menu, choose **3** (Link).

```

Configuration menu
-----
1) Channel
2) Profile
3) Link
4) System parameters
5) PVC
6) Call ID
7) NUI
8) Alias
9) Routing table
10) Funnel
11) X.32
12) Management
13) Multicast
14) IP configuration
15) ISDN configuration
16) SNA
CR) Exit

Select:

```

2. In the Link Configuration menu, choose **1** (Set Link type).

```

Link configuration
-----
1) Set Link type.
2) Display Links protocols.
3) Update Link parameters.
4) Display Links parameters.
CR) Exit

Select:

```

3. Choose the number of the Ethernet link that you want to configure (Link 1).

```

Link | 1 | 2 | 3 | 4 | 5 | 6 | 7 | 8 |
-----|-----|-----|-----|-----|-----|-----|-----|-----|
Prot | x.25 | x.25 | x.25 | x.25 | x.25 | x.25 | x.25 | x.25 |

Enter Link number to set:

```

The Ethernet Link x Configuration menu appears.

## 4. Choose the Ethernet Link type (11).

```

Link types
-----
1) X.25
2) FRAME RELAY
3) HDLC
4) SDLC
5) ASYNC
6) STM4/4HS
7) STM8/8HS
8) STM16/16HS
9) STM24/24HS
10) MPE (Multi Point Encapsulator)
11) ETHERNET
12) PPP
CR) Exit

Select: 11

```

The following message appears:

```

Setting link number 1 to ETHER protocol.
-----
*****
*
*                               W A R N I N G                               *
*
*           This action will set the link to ETHER                       *
*           default parameters.                                           *
*****

Are you sure ? (Y/N) y

```

## 5. Type Y to accept.

➤ **Set two links to Frame Relay**

- In this example, link 1 connects to PS4 and Link 2 connects to PS2 through Frame Relay links. Select two links and set their link types to Frame Relay. See *Frame Relay Link Configuration, "Terminal Configuration Procedures, ➤ Set a link to Frame Relay."* Perform all steps as instructed for each link.

➤ **Configure links 1 and 2 port parameters**

See *Frame Relay Link Configuration, "Terminal Configuration Procedures, ➤ Set the Frame Relay port parameters."*

➤ **Configure IP agent**

This procedure is required to enable SNMP management of this packet switch from a network management station at a remote site.



1. Press **ENTER** several times so that the Configuration menu reappears. In the Configuration menu, choose **12** (Management).

```

Configuration Menu
-----
1) Channel
2) Profile
3) Link
4) System parameters
5) PVC
6) Call ID
7) NUI
8) Alias
9) Routing table
10) Funnel
11) X.23
12) Management
13) Multicast
14) IP Configuration
15) ISDN configuration
16) SNA
CR) Exit

Select:

```

2. In the Management Configuration menu, choose **1** (SNMP Agent).

```

Management configuration
-----
1) SNMP Agent
2) Event Report
CR) Exit

Select:

```

3. In the SNMP Agent menu, choose **1** (Agent IP Configuration).

```

SNMP Agent
-----
1) Agent IP Configuration.
2) MIB System Group.
3) Management Stations.
CR) Exit

Select:

```

4. In the Agent IP Configuration menu, choose 1 (IP Address).

```

Agent IP Configuration
-----
1) IP Address [0.0.0.0.]
2) Authentication Trap [0 ]
3) IP Write Community [ ]
4) IP Read Community [public]
5) IP Trap Community [ ]
S) Save
CR) Exit
Select:

```

5. In the IP Address screen, type the IP address of the packet switch.

```
1) IP Address
Current value.....[0.0.0.0.]

Possible values:
A string of the format: X.X.X.X
Where every X is a number in the range 0 - 255.

Enter one of the above vales or <RETURN> to exit:
```

➤ **Configure IP Interface**

1. Press **ENTER** several times so that the Configuration menu reappears. In the Configuration menu, choose **14** (IP configuration).

```
Configuration Menu
1) Channel
2) Profile
3) Link
4) System parameters
5) PVC
6) Call ID
7) NUI
8) Alias
9) Routing table
10) Funnel
11) X.32
12) Management
13) Multicast
14) IP configuration
15) ISDN configuration
16) SNA
CR) Exit

Select:
```

2. In the IP configuration menu, choose **2** (IP interface).

```
IP Configuration
1) IP global parameters.
2) IP interface.
3) IP static route.
CR) Exit

Select:
```

3. In the IP Interface Configuration menu, choose **1** (Add IP Interface Entry).

```

IP Interface Configuration
1) Add IP Interface Entry.
2) Delete IP Interface Entry.
3) Update IP Interface Entry.
4) Display IP Interface Entry.
CR) Exit.

Select:

```

**Note**

*In step 3, when the destination is Ethernet, choose 3 (Update IP interface entry) instead of option 1 (Add IP interface entry) because the Ethernet destination is already defined automatically. Also, skip steps 11 and 12 (destination entry).*

4. The existing IP Interfaces appear. Enter IP Interface number (e.g. 1).

```

Existing IP Interfaces : 159,160

Enter IP Interface number (1..200):

```

**Notes**

*IP interfaces 159 and 160 are created automatically.*

*You can configure the IP interface in the RIP application with or without an IP address.*

*When configuring with the IP address, both IP interfaces of the link must be in the same subnet. Do not use the IP address when the number of available IP addresses is limited (skip steps 5 to 8 when using this option).*

5. In the IP Interface 1 Configuration menu, choose **1** (IP address).

```

IP Interface 1 Configuration
1) IP address ..... [0.0.0.0]
2) IP mask ..... [255.255.255.255]
3) RIP mode ..... [ 0 ]
4) Destination ..... [No Destination]
5) Default route metric ..... [Disabled]
6) Inactivity timer ..... [ ]
7) Link cost ..... [ 1 ]
8) Subnet learning mask ..... [0.0.0.0]
9) Options ..... [ 0 ]
S) Save.
CR) Exit.

Select:

```

6. In the IP address screen, enter the IP address (e.g. 194.114.31.8).

```

1) IP Address
.....
Current value ... [0.0.0.0]

Possible values:
A string of the format: X.X.X.X
Where every X is a number in the range 0 - 255.

Enter one of the above values or <RETURN> to exit:

```

IP Interface 1 Configuration menu appears.

7. In the IP Interface 1 Configuration menu, choose **2** (IP mask).

```

IP Interface 1 ..... Configuration
.....

1) IP address ..... [194.114.31.8]
2) IP mask ..... [255.255.255.255]
3) RIP mode ..... [ 0 ]
4) Destination ..... [No Destination]
5) Default route metric ..... [Disabled]
6) Inactivity timer ..... [ ]
7) Link cost ..... [ 1 ]
8) Subnet learning mask ..... [0.0.0.0]
9) Options ..... [ 0 ]
S) Save.
CR) Exit.

Select:

```

8. In the IP mask screen, enter the IP mask values (e.g. 255.255.255.254).

```

2) IP mask
.....
Current value ... [255.255.255.255]

Possible values:
A string of the format: X.X.X.X
Where every X is a number in the range 0 - 255.

Enter one of the above values or <RETURN> to exit:

```

IP Interface 1 Configuration menu appears with the new IP address and IP mask values .

9. In the IP Interface 1 Configuration menu, choose **3** (RIP mode)

```

IP Interface 1 ..... Configuration
.....

1) IP address ..... [194.114.31.8]
2) IP mask ..... [255.255.255.254]
3) RIP mode ..... [ 0 ]
4) Destination ..... [No Destination]
5) Default route metric ..... [Disabled]
6) Inactivity timer ..... [ ]
7) Link cost ..... [ 1 ]
8) Subnet learning mask ..... [0.0.0.0]
9) Options ..... [ 0 ]
S) Save.
CR) Exit.

Select:

```

10. In the RIP mode screen, Enter the value according to your network specifications.

```

3) RIP mode
This value defines RIP functionality.
The value is a sum of values (powers of two), where each value in
the sum represents options that are added to RIP functionality.
Example : 6 = RIP2 + Multicast RIP messages
Current value ... [ 0 ]

Possible values:
0 - Disable RIP
1 - RIP1
2 - RIP2
4 - Multicast RIP messages
8 - Default router message only
16 - Acknowledge RIP (2091)
xx - combination of the options above

Enter one of the above values or <RETURN> to exit:

```

IP Interface 1 Configuration menu appears with the new IP address, IP mask and RIP mode values .

**Note**

*Skip steps 11 and 12 for Ethernet destination.*

11. In the IP Interface 1 Configuration menu, choose **4** (Destination)

```

IP Interface 1 Configuration

1) IP address ..... [194.114.31.8]
2) IP mask ..... [255.255.255.254]
3) RIP mode ..... [ 2 ]
4) Destination ..... [No Destination]
5) Default route metric ..... [Disabled]
6) Inactivity timer ..... [ ]
7) Link cost ..... [ 1 ]
8) Subnet learning mask ..... [0.0.0.0]
9) Options ..... [ 0 ]
S) Save.
CR) Exit.

Select:

```

12. In the Destination screen, Enter the destination link number and DLCI number (e.g. 1:16)

```

4) Destination

Current value ... [No Destination]

Possible values:
No Destination: 'N'
X.25 PVC : Port:LCN
X.25 SVC : X25 Addr or 'cid' followed by a predefined Call
          ID number
Frame Relay: Port:DLCI
HDLC : 'H' followed by the HDLC port number
SLIP : 'S' followed by the SLIP port number
PPP : 'P' followed by the PPP port number
BUNDLE : 'B' followed by the PPP Bundle number
Ethernet : 'E' followed by the Ethernet port number

Enter one of the above values or <RETURN> to exit:

```

IP Interface 1 Configuration menu appears with the new IP address, IP mask, RIP mode and destination values .

The following steps 13 and 14 are recommended only.

13. In the IP Interface 1 Configuration menu, choose **9** (Options)

```

IP Interface 1 Configuration
-----
1) IP address ..... [194.114.31.8]
2) IP mask ..... [255.255.255.254]
3) RIP mode ..... [ 2 ]
4) Destination ..... [1:16 ]
5) Default route metric ..... [Disabled]
6) Inactivity timer ..... [ ]
7) Link cost ..... [ 1 ]
8) Subnet learning mask ..... [0.0.0.0]
9) Options ..... [ 0 ]
S) Save.
CR) Exit.

Select:

```

14. In the Options screen, enter the value **8** (Send alternative routes immediately).

```

9) Options
-----
Current value ... [ 0 ]

Possible values:
0 - No options.
1 - Priority according to source IP address.
2 - Priority according to destination IP address.
4 - Don't advertise routes that were learned from this
    interface.
8 - Send alternative routes immediately.
XX - Any combination of the values specified above.

Enter one of the above values or <RETURN> to exit:

```

IP Interface 1 Configuration menu appears with the new IP address, IP mask, RIP mode and destination values .

15. In the IP Interface 1 Configuration menu, choose **S** (Save)

```

IP Interface 1 Configuration
-----
1) IP address ..... [194.114.31.8]
2) IP mask ..... [255.255.255.254]
3) RIP mode ..... [ 2 ]
4) Destination ..... [1:16 ]
5) Default route metric ..... [Disabled]
6) Inactivity timer ..... [ ]
7) Link cost ..... [ 1 ]
8) Subnet learning mask ..... [0.0.0.0]
9) Options ..... [ 8 ]
S) Save.
CR) Exit.

Select:

```

For all the other Packet Switching devices, perform all the procedure as necessary.

---

---

## 2.25 Telnet Client

In this application, the packet switch device operates as a Telnet client, enabling connection of a terminal to a remote server through the Telnet protocol. Rad's packet switching devices support the connection of up to 15 remote locations to a single server using Telnet.

This section describes configuration procedures of a packet switching device for a Telnet client application. These procedures include:

- Update the profile for the X.28 channel connected to the terminal
- Set link 1 to Frame Relay
- Set the Frame Relay Link 1 port parameters
- Add IP Interfaces
- Add IP Static Routing
- Define the IP address of the PS

This section also includes a table detailing the Telnet commands supported by Rad's packet switching devices.

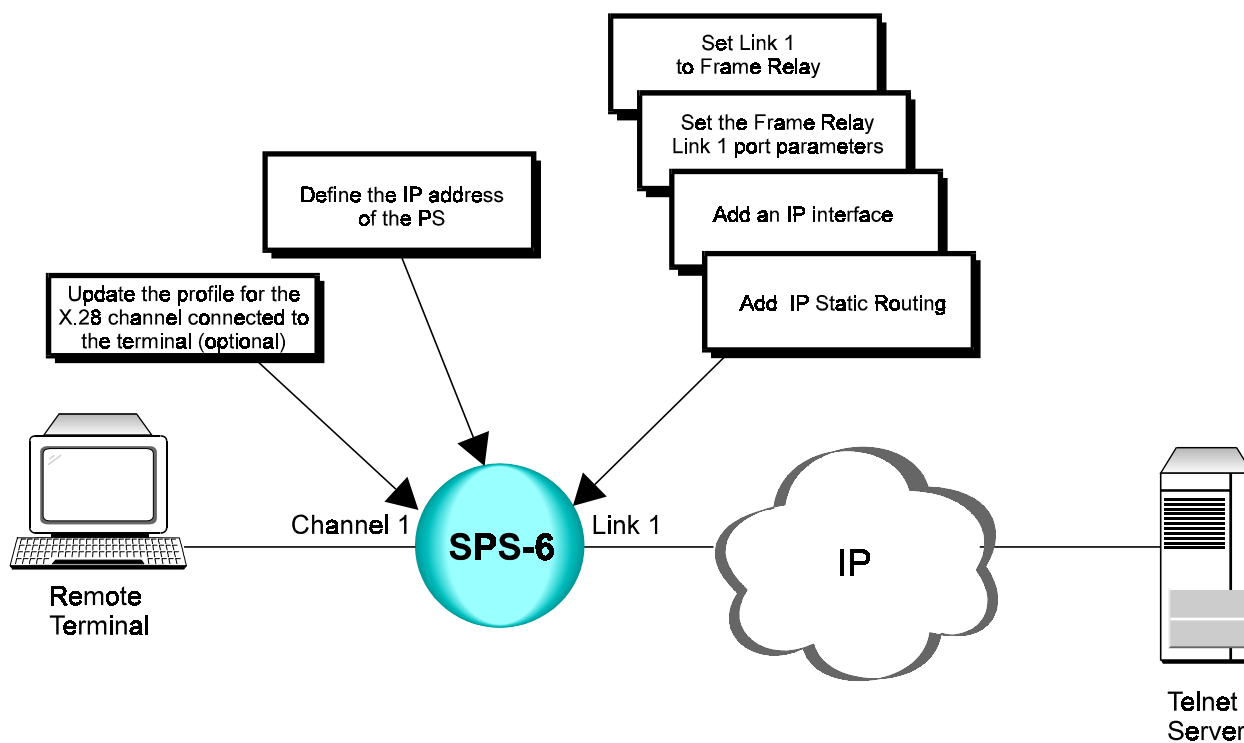

## Terminal Configuration Procedures



The following section describes terminal configuration procedures of a packet switching device in a Telnet client application.

- **Update the profile for the X.28 channel connected to the terminal**
  - See *Asynchronous Channel Configuration, "Terminal Configuration Procedures."* Perform all steps as instructed.
- **Set link 1 to Frame Relay**
  - See Section 3.3, *"Terminal Configuration Procedures, ➤ Set a link to Frame Relay."* Perform all steps as instructed for link 1.
- **Set the Frame Relay Link 1 port parameters**
  - See Section 3.3, *"Terminal Configuration Procedures, ➤ Set the Frame Relay port parameters."* Perform steps 1 to 5 of the procedure. Afterwards, perform the following steps:
    1. In the Maintenance Protocol Mode screen, choose **0** (User-side).

### 2) Maintenance protocol mode

This field defines the mode of maintenance protocol running over this port.  
Current value [1 ]

Possible values:

- 0 - Perform user-side procedure on this port.
- 1 - Perform network-side procedure on this port.
- 2 - Perform NNI (Network to Network Interface) procedure on this port.

Enter one of the above values or <RETURN> to exit:

2. In the Frame Relay Port x Configuration menu, change other port parameters according to your network specifications or keep their default values. Choose **S** to save the configuration.
- **Add IP Interfaces**
    - See *"IP Switching Procedures, ➤ Add IP Interfaces."* Perform all steps as instructed for link 1.
  - **Add IP Static Routing**
    - See *"IP Switching Procedures, ➤ Add an IP Static Routing entry for the link to Subnet 1."* Perform all steps as instructed for link 1.
  - **Define the IP Address of the PS**
    - See *"IP Switching Procedures, ➤ Set SNMP Management Parameters."* Perform steps 1-5 as instructed.



## Telnet Commands

This section lists the Telnet commands that are supported by Rad's packet switching devices. From the remote terminal, type the general commands listed below in order to perform the described functions.

**Note** *These commands are applicable only if the destination also supports them.*

Command	Function
<b>Telnet</b> X.X.X.X	Open a new Telnet session, where X.X.X.X is the IP address of the remote server.
<b>close</b>	Close the current Telnet session.
<b>CONTROL + P</b>	Display the Telnet prompt ( <b>Telnet&gt;</b> ).
<b>IP</b>	Interrupt Process, send interrupt to stop the process.
<b>ayt</b>	"Are you there" inquiry checks if there is communication between the terminal and the destination.
<b>ao</b>	"Abort output" command prevents the terminal from receiving output from the application running on the destination.
<b>quit</b>	Close the current Telnet session and exit from the Telnet environment.

---

## 2.26 Telnet Server

Most of the applications described in this guide assume the direct connection of a management terminal to the packet switching device. The Telnet server application enables the configuration and management of a packet switching device at a remote location over an IP network. The communication between the terminal and the device occurs through the Telnet environment.

This section describes configuration procedures of a packet switching device for a Telnet server application. These procedures include:

- Define the IP address of the packet switching device
- Set link 1 to Frame Relay
- Set the Frame Relay Link 1 port parameters
- Add IP Interfaces
- Add IP Static Routing

---

**Note** *To perform these procedures, you must connect a terminal directly to the packet switching device. The ability to perform management functions on the device is only available **after** successful completion of these procedures.*

---

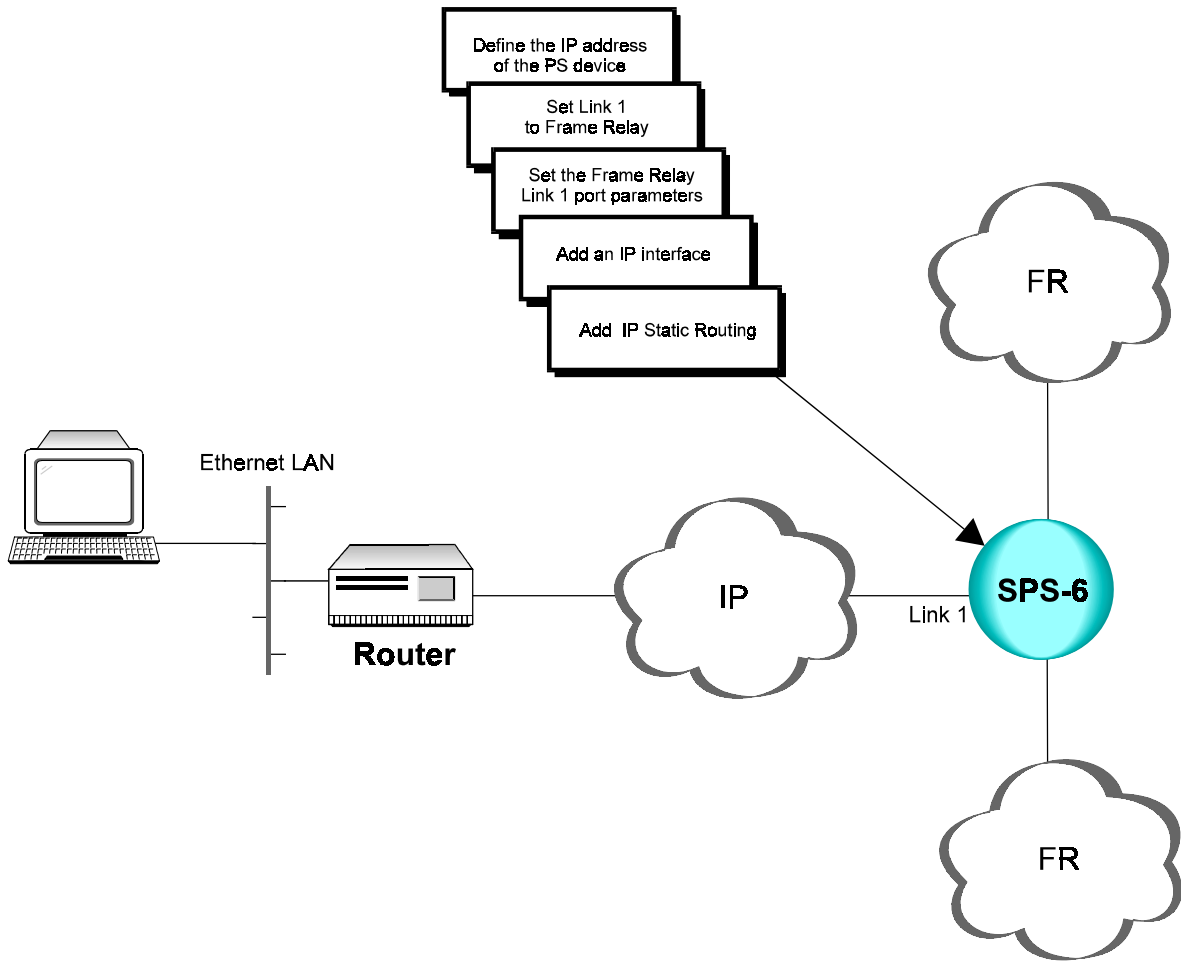

## Terminal Configuration Procedures



The following section describes terminal configuration procedures of a packet switching device in a Telnet server application.

➤ **Define the IP address of the packet switching device**

1. In the Configuration menu, choose **12** (Management).

```
Configuration menu
-----
1) Channel
2) Profile
3) Link
4) System parameters
5) PVC
6) Call ID
7) NUI
8) Alias
9) Routing table
10) Funnel
11) X.32
12) Management
13) Multicast
14) IP configuration
15) ISDN configuration
16) SNA
CR) Exit

Select:
```

2. In the Management Configuration menu, choose **1** (SNMP Agent).

```
Management Configuration
-----
1) SNMP Agent
2) Event Report

CR) Exit

Select:
```

3. In the SNMP Agent menu, choose **1** (Agent IP Configuration).

```
SNMP Agent
-----
1) Agent IP Configuration.
2) MIB System Group.
3) Management Stations.
CR) Exit.

Select:
```

4. In the Agent IP Configuration menu, choose **1** (IP Address).

```

Agent IP Configuration
-----
1) IP Address ..... [0.0.0.0]
2) Authentication Trap ..... [0   ]
3) IP Write Community ..... [   ]
4) IP Read Community ..... [public]
5) IP Trap Community ..... [   ]
S) Save.
CR) Exit.

Select:

```

5. In the IP Address screen, type the IP address of the packet switch.

```

1) IP Address
-----

Current value ... [0.0.0.0]

Possible values:
A string of the format: X.X.X.X
Where every X is a number in the range 0 - 255.

Enter one of the above values or <RETURN> to exit:

```

6. Change other Agent IP parameters according to your network's specifications or keep their default values. Choose **S** to save the configuration.

➤ **Set link 1 to Frame Relay**

- See Section 3.3, "Terminal Configuration Procedures, ➤ Set a link to Frame Relay." Perform all steps as instructed for link 1.

➤ **Set the Frame Relay Link 1 port parameters**

- See Section 3.3, "Terminal Configuration Procedures, ➤ Set the Frame Relay port parameters." Perform steps 1 to 5 of the procedure. Afterwards, perform the following steps:

1. In the Maintenance Protocol Mode screen, choose **0** (User-side).

```

2) Maintenance protocol mode

This field defines the mode of maintenance protocol running
over this port.
Current value [1   ]

Possible values:
0 - Perform user-side procedure on this port.
1 - Perform network-side procedure on this port.
2 - Perform NNI (Network to Network Interface) procedure on
this port.

Enter one of the above values or <RETURN> to exit:

```

2. In the Frame Relay Port x Configuration menu, change other port parameters according to your network specifications or keep their default values. Choose **S** to save the configuration.

➤ **Add IP Interfaces**

- See "*IP Swiching Procedures, ➤ Add IP Interfaces.*" Perform all steps as instructed for link 1.

➤ **Add IP Static Routing**

- See "*IP Swiching Procedures, ➤ Add an IP Static Routing entry for the link to Subnet 1.*" Perform all steps as instructed for link 1.

# Chapter 3

---

## Standard Channel/Link Configurations

This chapter contains typical configuration procedures for:

- X.28 (Asynchronous) channel
- X.25 link
- Frame Relay link
- HDLC link

These procedures include the usual steps for setting up a channel/link operating in one of the above-mentioned protocols. Unless noted otherwise, these procedures instruct you to set parameters according to your application's specifications instead of supplying specific settings.

A typical procedure from this chapter, or several of its steps, is often a part of the larger configuration process of an application described in Chapter 2. Chapter 2 contains references to these procedures at the appropriate places.

### 3.1 Asynchronous Channel Configuration

This appendix describes typical configuration procedures for an X.28 channel. These procedures include:

- Add and configure a channel profile
- Configure an X.28 (Asynchronous) channel.

The following section contains configuration procedures for setting up channel/links operating in various protocols.

#### Terminal Configuration Procedures



➤ **Add and configure a channel profile**

1. In the Configuration menu, choose **2** (Profile).

```
Configuration menu
-----
1) Channel
2) Profile
3) Link
4) System parameters
5) PVC
6) Call ID
7) NUI
8) Alias
9) Routing table
10) Funnel
11) X.32
12) Management
13) Multicast
14) IP configuration
15) ISDN configuration
16) SNA
CR) Exit

Select:
```

2. In the Profile Configuration menu, choose **1** (Add Profile).

```
Profile configuration
-----
1) Add profile
2) Delete profile
3) Update profile
4) Display profiles
CR) Exit

Select:
```



- The Profile x Configuration screen appears. Change profile parameters according to your network specifications or keep their default values. Choose **S** to save the profile.

```

Profile 1 configuration
-----
1) Recall char ..... [1 ] 20) Echomask ..... [0 ]
2) Echo ..... [1 ] 21) Parity treat ..... [3 ]
3) Data forward char .... [2 ] 22) Page wait ..... [0 ]
4) Idle timer..... [0 ] 100) Bits/char ..... [3 ]
5) Device flow control ... [2 ] 101) Dv_parity ..... [0 ]
6) Service signal ..... [5 ] 102) Stop bits ..... [0 ]
7) Break ..... [4 ] 103) Special flow ..... [0 ]
8) Discard output ..... [0 ] 104) Count fwd ..... [0 ]
9) CR padding ..... [0 ] 105) Esc_delay ..... [0 ]
10) Line folding ..... [0 ] 106) Character break ..... [0 ]
11) Speed ..... [14 ] 107) Character suppress .. [0 ]
12) Pad flow control ..... [1 ] 108) Character substitute [0 ]
13) Linefeed insertion .... [4 ] 109) Form feed padding ... [0 ]
14) Linefeed padding ..... [0 ] 110) Inactivity ..... [0 ]
15) Editing ..... [1 ] 111) Options ..... [0 ]
16) Character delete ..... [127 ] 112) Clr Timer ..... [0 ]
17) Line delete ..... [24 ] 113) Subaddress in CUD ... [2 ]
18) Line display ..... [18 ] 114) DNIC ..... [0 ]
19) Edit service signals .. [2 ] C) Copy
                                     S) Save      CR) Exit

Select:

```

➤ **Configure an X.28 channel**

**Note** *The default protocol of the packet switching device's channels is X.28.*

- Press **ENTER** several times so that the Configuration menu reappears. In the Configuration menu, choose **1** (Channel).

```

Configuration menu
-----
1) Channel
2) Profile
3) Link
4) System parameters
5) PVC
6) Call ID
7) NUI
8) Alias
9) Routing table
10) Funnel
11) X.32
12) Management
13) Multicast
14) IP configuration
15) ISDN configuration
16) SNA
CR) Exit

Select:

```

2. In the Channel Configuration menu, choose **3** (Update Channel).

```

Channel configuration
-----
1) Duplicate channel
2) Duplicate channel with mask
3) Update channel
4) Display channels
5) Set Channel Type
CR) Exit

select:

```

3. Choose the number of the channel that you want to configure.

```

Chan | 1 | 2 | 3 | 4 | 5 | 6 | 7 | 8 |
-----|-----|-----|-----|-----|-----|-----|-----|-----|
Prot | X.28 | X.28 | X.28 | X.28 | X.28 | X.28 | X.28 | X.28 |

Enter channel number to set:

```

4. In the Channel x Configuration menu, choose **1** (Profile Number).

```

Channel 1 configuration
-----
1) Profile number ..... [1 ]
2) Outgoing call profile number ... [0 ]
3) Incoming call profile number ... [0 ]
4) Remote profile number ..... [0 ]
5) Autocall ID ..... [0 ]
6) Alternate autocall ID ..... [0 ]
7) Autocall retries ..... [10 ]
8) Autocall retry interval ..... [5 ]
9) Call alias ..... [0 ]
10) Sub address1 ..... [00 ]
11) Sub address2 ..... [00 ]
12) NUI Group ID ..... [0 ]
13) Clear timer ..... [0 ]
14) Options ..... [0 ]
S) Save
CR) Exit

Select:

```

5. In the Profile Number screen, choose the number of the profile that you configured or the number of another existing profile.

```

1) Profile number
-----
Current value ... [1 ]

Possible values:
1.. 200

Enter one of the above values or <RETURN> to exit:

```

6. In the Channel x Configuration menu, choose **S** to save the configuration.

## RADview Configuration Procedure



The following section contains RADview configuration procedures for setting up channel/links operating in various protocols.

### ➤ Add and configure a channel profile

1. Click in the PS View window without clicking a channel or link. On the **Configuration** menu, point to **Async Global Param, Profiles** and click **Full Config** (or **Quick Config**).
2. In the Profile Full (or Quick) Config table, click **Scratch** to switch to the Scratch Configuration mode and then click **Add**.

	1	2
1-Recall Char(ASCII)	1	0
2-Echo	Echo Enabled	No Echo
3-Data Forwarding Char	2	0
4-Idle Timer (x50 msec)	0	3
5-Device Flow Control	Transfer & Comm	Transfer & Comm
6-Service Signal	Svc & Prompt	No Svc Sig
7-Break	4	4
8-Discard Output	Normal	Normal
9-CR Padding	0	0
10-Line Folding	0	0
11-Speed (bps)	9600	9600
12-PAD Flow Control	Flow Control	Flow Control
13-Line Feed Insert	Echo CR	No LF
14-Line Feed Padding	0	0

3. In the Add Profile Full (or Quick) Config dialog box, change profile parameters according to your network specifications or keep their default values. Click **Set**.

4. In the Profile Full (or Quick) Config table, click **Refresh** to display the new profile.

5. To save the new profile as active, click the profile, click **Save** and then **Entry**.  
To save the complete profile as active, click **Save** and then **All**.

➤ **Configure an Asynchronous channel**

1. In the PS View window, double-click a channel. The Async window appears.

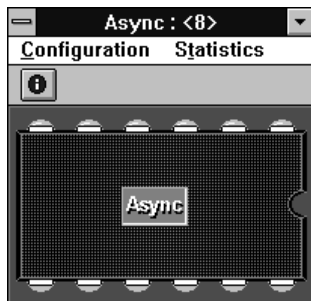

2. In the Async window, click **Async**. In the Async **Configuration** menu, click **Parameters**.

sps6/79[A]: Async Parameters		
Index:	<input type="text" value="8"/>	<input type="button" value="Set"/>
Channel Number:	<input type="text" value="2"/>	<input type="button" value="Cancel"/>
Profile:	<input type="text" value="1"/>	<input type="button" value="Scratch"/>
Out Call Profile:	<input type="text" value="0"/>	
In Call Profile:	<input type="text" value="0"/>	
Remote Profile:	<input type="text" value="0"/>	
Autocall Id:	<input type="text" value="0"/>	
Alter Autocall Id:	<input type="text" value="0"/>	
Autocall Retries:	<input type="text" value="10"/>	
Autocall Interval (sec):	<input type="text" value="5"/>	
Call Alias:	<input type="text" value="0"/>	
Sub Address 1:	<input type="text" value="0"/>	
Sub Address 2:	<input type="text" value="0"/>	
Clear Timer (min):	<input type="text" value="0"/>	
Options:	<input type="text" value="0"/>	

3. In the Async Parameters dialog box, click **Scratch** to switch to the Scratch configuration. Change parameters according to your network specifications or keep their default values. Click **Set**.

---

## 3.2 X.25 Link Configuration

This appendix describes typical configuration procedures for an X.25 link. These procedures include:

- Select an X.25 link
- Set X.25 link parameters
- Add a routing table entry.

### Terminal Configuration Procedures

- The following steps describe configuration procedures for an X.25 link
- **Select an X.25 link**



**Note** *The default protocol of the packet switching device's links is X.25.*

1. In the Configuration menu, choose **3** (Link).

```
Configuration menu
-----
1) Channel
2) Profile
3) Link
4) System parameters
5) PVC
6) Call ID
7) NUI
8) Alias
9) Routing table
10) Funnel
11) X.32
12) Management
13) Multicast
14) IP configuration
15) ISDN configuration
16) SNA
CR) Exit

Select:
```

2. In the Link Configuration menu, choose **3** (Update Link Parameters).

```
Link configuration
-----
1) Set Link type.
2) Display Links protocols.
3) Update Link parameters.
4) Display Links parameters.
CR) Exit

Select:
```

3. Choose the number of the link that you want to configure.

```

Link | 1 | 2 | 3 | 4 | 5 | 6 |
-----|-----|-----|-----|-----|-----|-----|
Prot | X.25 | X.25 | X.25 | X.25 | X.25 | X.25 |
    
```

▶ Enter Link number to set:

➤ **Set X.25 link parameters**

**Note** Check if the selected X.25 interface is DCE or DTE, depending on your network specifications.

1. In the Link x Configuration menu, choose **2** (DCE/DTE).

```

X.25 Link 1 configuration
-----
1) Address ..... [0 ] 17) LGN ..... [0 ]
2) DCE (1) / DTE (0)..... [1 ] 18) Lowest LCN (LIC) ..... [1 ]
3) Extended mode ..... [0 ] 19) Amount of Incoming LCNs .. [5 ]
4) T1 ..... [5 ] 20) Amount of Two Way LCNs ... [5 ]
5) T3 ..... [20 ] 21) Amount of Outgoing LCNs .. [5 ]
6) N2 ..... [10 ] 22) Internal Clock ..... [0 ]
7) k ..... [7 ] 23) LINE option ..... [1024 ]
8) w ..... [2 ] 24) Segment Size..... [128 ]
9) T10 ..... [18 ] 25) Xid num ..... [0 ]
10) T11 ..... [20 ] 26) NUI Group ID ..... [0 ]
11) T12 ..... [18 ] 27) Physical interface option. [0 ]
12) T13 ..... [18 ] 28) X.25 Acknowledge Counter . [1 ]
13) Packet size ..... [128 ] 29) X.25 Acknowledge Timer ... [0 ]
14) In call options ..... [1 ] 30) LAPB Acknowledge Counter . [1 ]
15) Out call options ..... [1 ] 31) LAPB Acknowledge Timer ... [0 ]
16) Subaddress length ..... [2 ] 32) CUG subscription ..... [5 ]
S) Save
CR) Exit

Select:
    
```

2. In the DCE/DTE screen, choose the option number according to your network specifications.

```

2) DCE/DTE
-----
Current value ... [1 ]

Possible values:
0 - The link appears as a X25 DTE.
1 - The link appears as a X25 DCE.
2 - The link is X25->DCE and LAPB->DTE.
3 - The link is X25->DTE and LAPB->DCE.

▶ Enter one of the above values or <RETURN> to exit:
    
```

3. The Link x Configuration menu reappears. If the selected link is DCE, choose **22** (Internal Clock) to set the baud rate of the link, if necessary.

4. In the Internal Clock menu, choose the option number according to your specifications.

```

      22) Internal Clock
      -----
Current value ... [0    ]

Possible values:

      0 - External clock

              Internal Clock
      -----
      1 - 2.4 Kbps      10 - 128 Kbps
      2 - 4.8 Kbps      11 - 256 Kbps
      3 - 9.6 Kbps      12 - 384 Kbps
      4 - 14.4 Kbps     13 - 512 Kbps
      5 - 19.2 Kbps     14 - 768 Kbps
      6 - 38.4 Kbps     15 - 1008 Kbps
      7 - 48 Kbps       16 - 1466 Kbps
      8 - 56 Kbps       17 - 2016 Kbps
      9 - 64 Kbps

▶ Enter one of the above values or <RETURN> to exit:

```

5. In the Link x Configuration menu, change other parameters according to your specifications or keep their default values. Choose **S** to save the configuration.

➤ **Add a routing table entry**

1. Press **ENTER** several times so that the Configuration menu reappears. In the Configuration menu, choose **9** (Routing Table).

```

      Configuration menu
      -----
      1) Channel
      2) Profile
      3) Link
      4) System parameters
      5) PVC
      6) Call ID
      7) NUI
      8) Alias
      9) Routing table
     10) Funnel
     11) X.32
     12) Management
     13) Multicast
     14) IP configuration
     15) ISDN configuration
     16) SNA
     CR) Exit

      Select:

```

2. In the Routing Table Entry Configuration menu, choose **1** (Add Routing Table Entry).

```

Routing Table entry configuration
-----
1) Add Routing Table entry
2) Delete Routing Table entry
3) Update Routing Table entry
4) Display Routing Table entries
CR) Exit

Select:

```

3. In the Routing Table Entry x Configuration menu, choose **1** (Link).

```

Routing table entry 1 configuration
-----
1) Link ..... [1      ] ----> 6) Priority ..... [1    ]
2) Link ..... [0      ] ----> 7) Priority ..... [1    ]
3) Link ..... [0      ] ----> 8) Priority ..... [1    ]
4) Address ..... [      ]
5) Stop search ... [1    ]
S) Save
CR) Exit

Select:

```

4. In the Destination Link screen, type the main destination link number according to your network specifications.

```

1) Destination link

Current value ... [1    ]

Possible values:
L - local channel.
Any valid X.25 link number.
Any valid FRAME RELAY DLCI with an X.25 destination protocol,
the DLCI is presented in the form of {port:DLCI}
ISDN routing entry number preceded by the letter 'I' (i.e.: I5)

Enter one of the above values or <RETURN> to exit:

```

5. In the Routing Table Entry x Configuration menu, choose **4** (Address). In the Address screen, type the address of the destination link according to your network specifications.

```

4) Address
-----
Current value ... [      ]

Possible values:
Up to 15 decimal digits or X (don't care) digits.

Enter one of the above values or <RETURN> to exit:

```

6. In the Routing Table Entry x Configuration menu, choose **S** to save the configuration.



## RADview Configuration Procedure

The following steps describe RADview configuration procedures for an X.25 link

- **Select an X.25 link**



### Note

The default protocol of the packet switching device's links is X.25.

- In the PS View window, click an X.25 link on the rear panel.

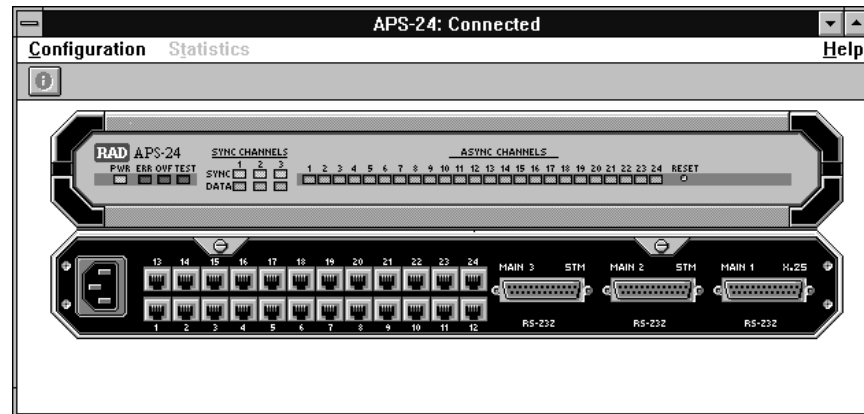

- **Set X.25 link parameters**

### Note

Check if the selected X.25 interface is DCE or DTE, depending on your network specifications.

1. In the PS View window, double-click the X.25 link. The X.25 window appears.

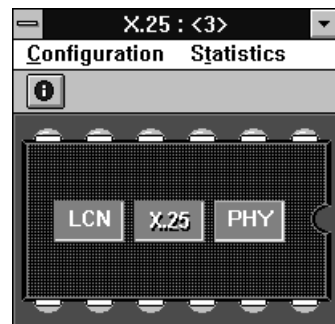

2. In the X.25 window, click **X.25**. On the X.25 **Configuration** menu, point to **Parameters** and click **Quick Config**. In the X.25 Quick Config dialog box, click **Scratch** to switch to the Scratch configuration mode.

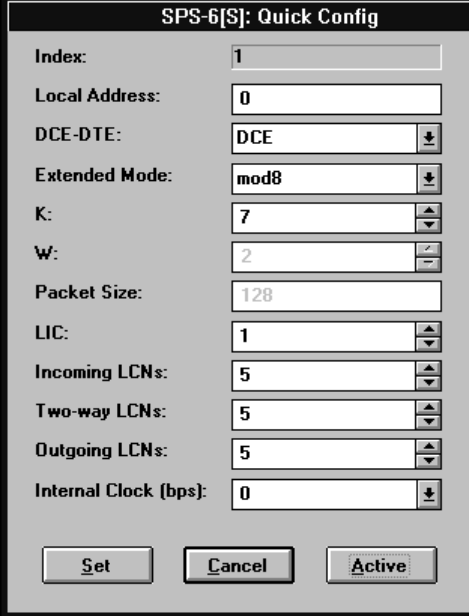

SPS-6[S]: Quick Config

Index:	1
Local Address:	0
DCE-DTE:	DCE
Extended Mode:	mod8
K:	7
W:	2
Packet Size:	128
LIC:	1
Incoming LCNs:	5
Two-way LCNs:	5
Outgoing LCNs:	5
Internal Clock (bps):	0

Set Cancel Active

3. In the DCE/DTE list, click the option according to your network specifications.
4. If the selected link is **DCE**, click the Internal Clock list arrow and click the baud rate according to your specifications.
5. Change other link parameters according to your specifications or keep their default values. Click **Set**.

**Note**

Additional X.25 link parameters appear in the X.25 Full Config dialog box. To open the X.25 Full Config dialog box, open the X.25 window **Configuration** menu, point to **Parameters** and click **Full Config**.

➤ **Add a routing table entry**

1. Click the PS View window without selecting a link or channel. On the **Configuration** menu, point to **Sync Global Param, Routing Information** and click **Table**.

APS-24[S]: Routing Table	
ID	1
Address	0
Destination Link1	1
Destination Link2	No dest link
Destination Link3	No dest link
Link Priority1	1
Link Priority2	1
Link Priority3	1
Search Status	On

Buttons: Add..., Change..., Remove, Save, Active, Done, Refresh

2. In the Routing Table, click **Scratch** to switch to the Scratch Configuration mode and then click **Add**.

**Add: Routing Table**

ID: 1

Address: 0

Destination Link1: 1

Destination Link2: No dest link

Destination Link3: No dest link

Link Priority1: 1

Link Priority2: 1

Link Priority3: 1

Search Status:

Buttons: Set, Cancel

3. In the Address box, type the address of the destination port according to your network specifications.
4. In the Destination Link 1 list, click a port number.
5. Click **Set**.
6. In the Routing Table, click **Refresh** to display the new routing configuration.

### 3.3 Frame Relay Link Configuration

This appendix describes typical configuration procedures for a Frame Relay link. These procedures include:

- Set a link to Frame Relay
- Set the Frame Relay port parameters
- Add and configure a DLCI.

#### Terminal Configuration Procedures



The following steps describe configuration procedures for a Frame Relay link.

#### ➤ Set a link to Frame Relay

1. In the Configuration menu, choose **3** (Link).

```

Configuration menu
-----
1) Channel
2) Profile
3) Link
4) System parameters
5) PVC
6) Call ID
7) NUI
8) Alias
9) Routing table
10) Funnel
11) X.32
12) Management
13) Multicast
14) IP configuration
15) ISDN configuration
16) SNA
CR) Exit

Select:

```

2. In the Link Configuration menu, choose **1** (Set Link Type).

```

Link configuration
-----
1) Set Link type.
2) Display Links protocols.
3) Update Link parameters.
4) Display Links parameters.
CR) Exit

Select:

```

3. Choose the number of the link that you want to set to Frame Relay.

Link	1	2	3	4	5	6
Prot	X.25	X.25	X.25	X.25	X.25	X.25

▶ Enter Link number to set:

4. In the Link Types menu, choose **2** (Frame Relay).

```

Link types
-----
1) X.25
2) FRAME RELAY
3) HDLC
4) SDLC
5) ASYNC
6) STM4/4HS
7) STM8/8HS
8) STM16/16HS
9) STM24/24HS
10) MPE (Multi Point Encapsulator)
11) ETHERNET
12) PPP
CR) Exit

Select:

```

5. A warning appears stating that this action will set this FR link's parameters to their default values. Choose **Y** to continue.

➤ **Set the Frame Relay port parameters**

1. Press ENTER several times so that the Link Configuration menu reappears. In the Link Configuration menu, choose **3** (Update Link Parameters).

```

Link configuration
-----
1) Set Link type.
2) Display Links protocols.
3) Update Link parameters.
4) Display Links parameters.
CR) Exit

Select:

```

2. Choose the number of the Frame Relay link that you want to update.

Link	1	2	3	4	5	6
Prot	FR	X.25	X.25	X.25	X.25	X.25

▶ Enter Link number to update:

3. In the Frame Relay Link x Configuration menu, choose **3** (Update Port Parameters).

```

FRAME RELAY Link 1      configuration
-----
1) Add DLCI.
2) Delete DLCI.
3) Update PORT parameters.
4) Update DLCI parameters.
CR) Exit

Select:

```

4. In the Frame Relay Port x Configuration menu, choose **1** (Maintenance Protocol).

```

FRAME RELAY port 1      configuration
-----
1) Maintenance protocol ..... [1    ]
2) Maintenance protocol mode ..... [1    ]
3) T391 (Link Integrity Verification Timer) .. [10   ]
4) T392 (Link Polling Verification Timer) ... [15   ]
5) N391 (Full Status Polling Cycle) ..... [6    ]
6) N392 (Error Threshold) ..... [3    ]
7) N393 (Monitored Events Count) ..... [4    ]
8) Rx pool red line (Frames)..... [4    ]
9) Rx pool OK (Frames)..... [6    ]
10) Tx pool red line (Frames)..... [40   ]
11) Tx pool OK (Frames)..... [30   ]
12) Tx ceiling (Frames)..... [50   ]
13) Internal Clock ..... [0    ]
14) HDLC options ..... [0    ]
15) Physical interface option ..... [0    ]
16) DLCI Header Mode ..... [0    ]

S) Save
CR) Exit

Select:

```

5. In the Maintenance Protocol screen, choose the number of the option that matches the maintenance protocol of the connected device.

```

1) Maintenance protocol
-----
This field defines what maintenance protocol is running over this port.
Current value ... [1    ]

Possible values:
0 - No maintenance protocol.
1 - ANSI PVC (T1.617 Annex D) maintenance protocol Running on DLCI
  number 0.
2 - LMI maintenance protocol Running on DLCI number 1023.
4 - CCITT Q.933 ANNEX A maintenance protocol Running on DLCI number 0.
8 - Consolidate Link Layer Management CLLM Running on DLCI number 1023.
XXX - Any combination of 9, 12.

Enter one of the above values or <RETURN> to exit:

```

6. In the Frame Relay Port x Configuration menu, choose **2** (Maintenance Protocol Mode). In the Maintenance Protocol Mode screen, choose the number of the option that specifies the side of this connection that initiates the maintenance protocol.

```

2) Maintenance protocol mode
-----
This field defines the mode of maintenance protocol running
over this port.
Current value ... [1  ]

Possible values:
0 - Perform user-side procedure on this port.
1 - Perform network-side procedure on this port.
2 - Perform NNI (Network to Network Interface) procedure
   on this port.

```

▶ Enter one of the above values or <RETURN> to exit:

7. In the Frame Relay Port x Configuration menu, change other port parameters according to your network specifications or keep their default values. Choose **S** to save the configuration.

➤ **Add and configure a DLCI**

1. Press **ENTER** several times so that the Frame Relay Link x Configuration menu reappears. Choose **1** (Add DLCI).

```

FRAME RELAY Link 1 configuration
-----
1) Add DLCI.
2) Delete DLCI.
3) Update PORT parameters.
4) Update DLCI parameters.
CR) Exit

```

Select:

Type a number for the new DLCI (**16 to 991**).

2. In the DLCI xxx Link x menu, choose **1** (Update DLCI Configuration).

```

DLCI 100 Link 3
-----
1) Update DLCI configuration.
2) Update X25 configuration.
CR) Exit

```

Select:

3. In the DLCI xxx Link x Configuration menu, choose **1** (Encapsulation Type).

```

DLCI 100  Link 3  configuration
-----
1) Encapsulation Type ..... [2  ]
2) Destination Id ..... [0:0  ]
3) Backup DLCI ..... [0:0  ]
4) Tx Tc (1/10 Sec) ..... [10  ]
5) Tx Bc (Bytes per Tx Tc) ..... [65000]
6) Tx Be (Bytes per Tx Tc) ..... [65000]
7) Rx Tc (1/10 Sec) ..... [10  ]
8) Rx Bc (Bytes per Rx Tc) ..... [65000]
9) Rx Be (Bytes per Rx Tc) ..... [65000]
10) Funnel id ..... [0  ]
11) Tx Priority ..... [0  ]
12) ISDN Destination ..... [0  ]
S) Save
CR) Exit

Select:

```

4. In the Encapsulation Type screen, choose the number of the option according to your network specifications.

```

1) Encapsulation Type
-----
Current value ... [2  ]

Possible values:
1 - X25 encapsulation.
2 - No protocol encapsulation.
3 - Transparent HDLC encapsulation.
4 - Asynchronous encapsulation.
5 - Multi Point Encapsulation.
6 - RFC1490 encapsulation.
7 - Multicast

Enter one of the above values or <RETURN> to exit:

```

5. In the DLCI xxx Link x Configuration menu, change other DLCI parameters according to your network specifications or keep their default values. Choose **S** to save the configuration.



## RADview Configuration Procedure



The following steps describe RADview configuration procedures for a Frame Relay link.

### ➤ Set a link to Frame Relay

1. In the PS View window, click a link on the rear panel.

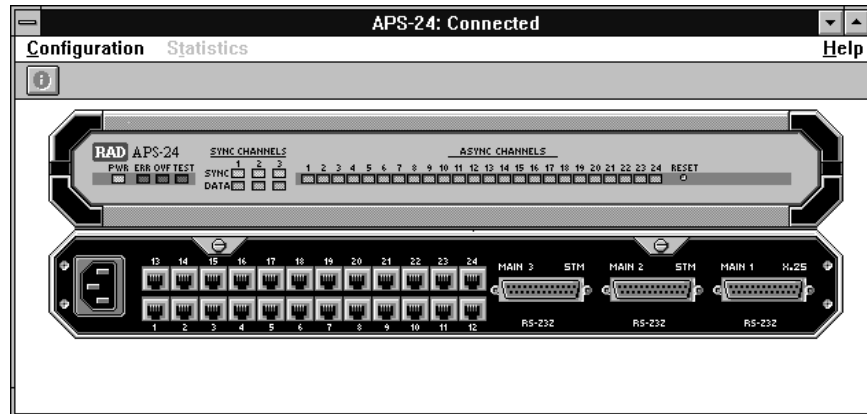

2. On the **Configuration** menu, click **Protocol Type**. In the Protocol Type dialog box, click **Scratch** to switch to the Scratch configuration mode.

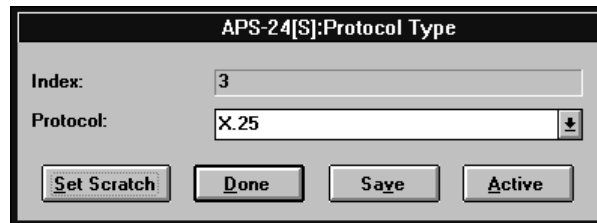

3. In the Protocol list box, click **FR**. Click **Set Scratch** to set the selected protocol in the Scratch configuration.
4. Click **Save**. Click **OK** to confirm. Perform reset to implement the protocol type change.

➤ **Set the Frame Relay port parameters**

1. In the PS View window, double-click the Frame Relay link. The FR window appears.

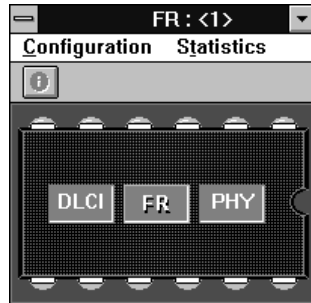

2. In the FR window, click **FR**. On the FR **Configuration** menu, point to **Parameters** and click **Full Config**.

 A screenshot of a dialog box titled "APS-24 [A]: FR Full Config". It contains a list of configuration parameters, each with a text input field:
 

Index:	1
Maintenance Protocol:	ANSI PVC running on DLCI 0
Maintenance Mode:	User
Polling Interval (sec):	10
Full Enquiry Interval:	6
Error Threshold:	3
Monitored Events:	4
Rx Pool Red Line:	4
Rx Pool Ok:	6
Tx Pool Red Line:	40
Tx Pool Ok:	30
Tx Ceiling:	50
Internal Clock (bps):	External
NRZ Mode:	NRZ

 At the bottom of the dialog box are three buttons: "Set", "Cancel", and "Scratch".

3. In the FR Full Config dialog box, click **Scratch** to switch to the Scratch configuration mode. Change port parameters according to your specifications or keep their default values. Click **Set**.

➤ **Add and configure a DLCI**

1. In the FR window, click **DLCI**. On the DLCI **Configuration** menu, click **Parameters**.

APS-24[A]: DLCI Parameters

Index: 1

Destination Protocol	0	
Destination Id	None	
Backup Id:	0:0	
Tx CIR Interval (0.1 sec)	10	
Tx Committed (byte/interval)	3200	
Tx Excess (byte/interval)	6400	
Rx CIR Interval (0.1 sec)	10	
Rx Committed (byte/interval)	3200	
Rx Excess (byte/interval)	6400	
Funnel Id	0	

Buttons: Add... Change... Copy... Remove Save Scratch Refresh

Buttons: X.25 Full Config... X.25 Quick Config... X.25 LCN... Done

2. In the DLCI Parameters table, click **Scratch** to switch to the Scratch configuration mode and then click **Add**.
3. In the Add DLCI Parameters dialog box, change DLCI parameters according to your network specifications or keep their default values. Click **Set**.

Add: DLCI Parameters<1>

DLCI Index: 16

Destination Protocol: None

Destination Id: 0:0

Backup Id: 0:0

Tx CIR Interval (0.1 sec): 10

Tx Committed (byte/interval): 3200

Tx Excess (byte/interval): 6400

Rx CIR Interval (0.1): 10

Rx Committed (byte/interval): 3200

Rx Excess (byte/interval): 6400

Funnel Id: 0

Buttons: Set Cancel

4. In the DLCI Parameters table, click the new DLCI, click **Save** and then click **Entry**.  
To save the complete DLCI table, click **Save** and then click **All**.

---

### 3.4 HDLC Link Configuration

This appendix describes typical configuration procedures for an HDLC link. These procedures include:

- Set a link to HDLC
- Set the HDLC link parameters.

#### Terminal Configuration Procedures



The following steps describe configuration procedures for an HDLC link

➤ **Set a link to HDLC**

1. In the Configuration menu, choose **3** (Link).

```
Configuration menu
-----
1) Channel
2) Profile
3) Link
4) System parameters
5) PVC
6) Call ID
7) NUI
8) Alias
9) Routing table
10) Funnel
11) X.32
12) Management
13) Multicast
14) IP configuration
15) ISDN configuration
16) SNA
CR) Exit

Select:
```

2. In the Link Configuration menu, choose **1** (Set Link Type).

```
Link configuration
-----
1) Set Link type.
2) Display Links protocols.
3) Update Link parameters.
4) Display Links parameters.
CR) Exit

Select:
```

3. Choose the number of the link that you want to set as HDLC.

Link	1	2	3	4	5	6
Prot	X.25	X.25	X.25	X.25	X.25	X.25

▶ Enter Link number to set:

4. In the Link Types menu, choose **3** (HDLC).

```

Link types
-----
1) X.25
2) FRAME RELAY
3) HDLC
4) SDLC
5) ASYNC
6) STM4/4HS
7) STM8/8HS
8) STM16/16HS
9) STM24/24HS
10) MPE (Multi Point Encapsulator)
11) ETHERNET
12) PPP
CR) Exit

Select:

```

5. A warning appears stating that this action will set this HDLC link's parameters to their default values. Choose **Y** to continue.

➤ **Set the HDLC link parameters**

1. Press **ENTER** several times so that the Link Configuration menu reappears. In the Link Configuration menu, choose **3** (Update Link Parameters).

```

Link configuration
-----
1) Set Link type.
2) Display Links protocols.
3) Update Link parameters.
4) Display Links parameters.
CR) Exit

Select:

```

2. Choose the number of the HDLC link that you want to update.

Link	1	2	3	4	5	6
Prot	HDLC	X.25	X.25	X.25	X.25	X.25

▶ Enter Link number to update:

3. In the HDLC Link x Configuration menu, change parameters according to your network's specifications or keep their default values. Choose **S** to save the configuration.

```
HDLC link 8 configuration
-----

X25 Parameters:
 1) Destination address ..... [0 ]
 2) Destination subaddr ..... [1 ]
 3) Redial time-out ..... [2 ] 6) X25 facilities ..... [0
]
 4) Redial retries ..... [5 ] 7) Local subaddress1 ... [1
]
 5) Inactivity ..... [0 ] 8) Local subaddress2 ... [1
]

FR Parameters:
 9) Destination port ..... [0 ]
10) Destination DLCI ..... [0 ]

General Parameters:
11) Protocol ..... [1 ] 14) Internal Clock .....
[0 ]
12) Flow control options .... [0 ] 15) NRZ mode .....
[0 ]
13) Buffer flow control ..... [10 ]

 S) Save
CR) Exit

Select:
```

## RADview Configuration Procedure



The following steps describe RADview configuration procedures for an HDLC link

➤ **Select a link to HDLC**

1. In the PS View window, click a link on the rear panel.

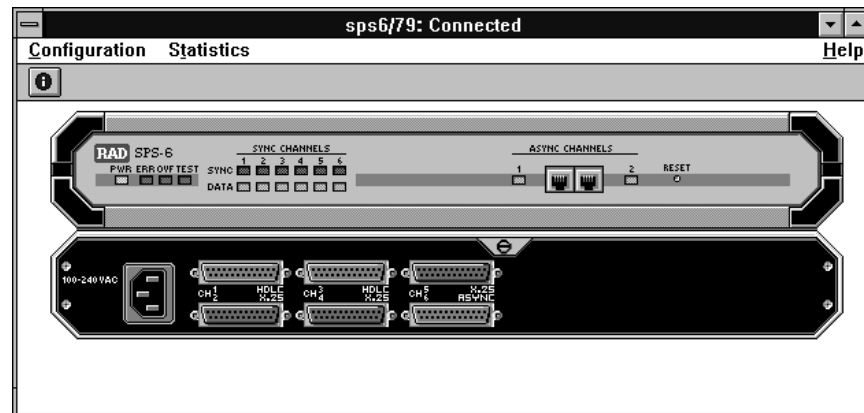

2. On the **Configuration** menu, click **Protocol Type**. In the Protocol Type dialog box, click **Scratch** to switch to the Scratch configuration mode.

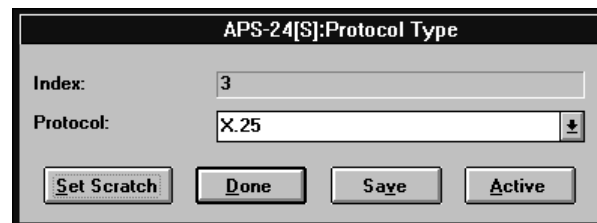

3. In the Protocol list box, click **HDLC**. Click **Set Scratch** to set the selected protocol in the Scratch configuration.
4. Click **Save**. click **OK** to confirm. Perform reset to implement the protocol type change.

➤ **Set the HDLC link parameters**

1. In the PS View window, double-click the HDLC link. The HDLC window appears.

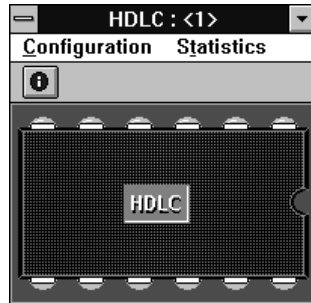

2. In the HDLC window, click **HDLC**. On the HDLC **Configuration** menu, click **Parameters**. In the HDLC Parameters dialog box, click **Scratch** to switch to the Scratch configuration mode.

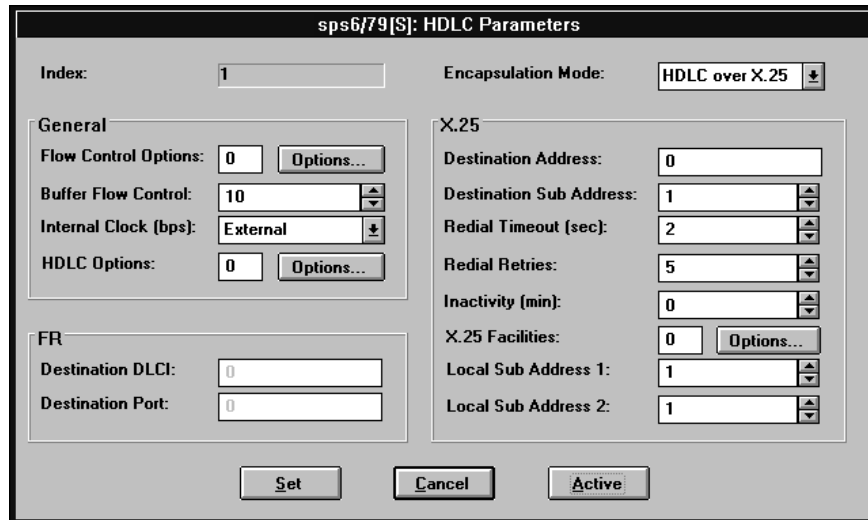

3. Change HDLC parameters according to your specifications or keep their default values. Click **Set**.
4. In the HDLC window, open the **Configuration** menu and click **Save**. Click **OK** to confirm.